

PRODUCT INFORMATION

ALPHA

 70 - 500 kg

 108 - 240 mm

 80 - 200 mm

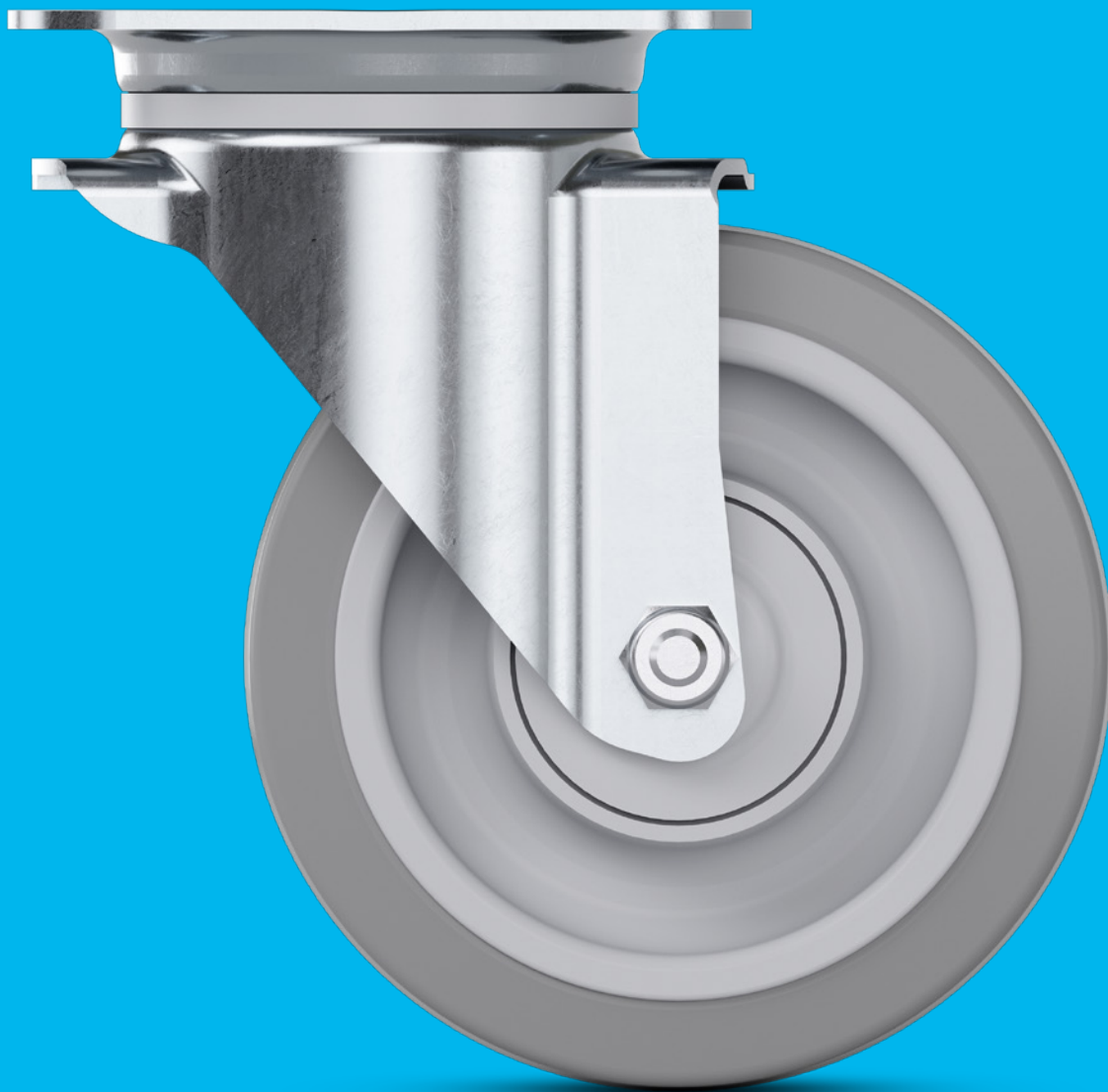

TENTE

BETTER MOBILITY. BETTER LIFE.

HOUSINGS

PAGES: 4-11

WHEELS

PAGES: 12-19

FITTINGS

PAGES: 20-27



BETTER MOBILITY IN PREMIUM QUALITY

TENTE believes in smart mobility solutions which noticeably improve people's lives and their working environment. Our solutions can increase productivity, enhance safety and open up new horizons in terms of design, durability and environmental friendliness. Leading manufacturers and companies of different industries rely on these features and our high production quality.

On the following pages you will find technical information about our Alpha product family. We will also explain the added value which this mobility solution offers for your company. Features include:

Ergonomically friendly

Wheels with optimised roll resistance to lighten the load for the user.

Uninterrupted use

Swivel bearing with dust ring for continuous, uninterrupted movement.

Tested quality

Tested in our own laboratory for compliance with European standards.

HOUSINGS



FEATURES



Practical system solution

With all technical components for central locking.

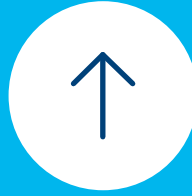

Optimised steering mechanism

Directional lock for improved steering around bends, as well as moving in a straight line for long distances.



Secure stand

Total lock for simultaneously locking the wheel and swivel housing.



User-friendly central lock

You can simultaneously lock more than one castor using a central activation lever.



Certified conductivity

Conductive versions to protect users and electrical devices from electrostatic discharge.



Permanent washability

Items made with stainless steel components available. These are ideal for use in damp and wet environment.



Easy steering

Double ball bearing swivel head.



Colour matching

Colours can be adapted to match the product design.

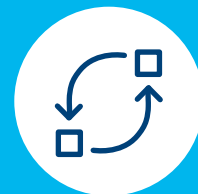

Resource-conserving part replacement

Threaded axles allow effortless wheel change.

HOUSINGS

We have two different types of housings: pressed steel and stainless steel. Materials are tested in our own laboratory for compliance with European standards. Non hazardous materials are used in order to comply with the RoHS directive and the European Union's REACH regulation. These do not contain polycyclic aromatic hydrocarbons or chromium (VI).

Swivel castor

Wheel and housing are free to move in any direction. The housing can be retrofitted with a directional lock option.



Central wheel brake

Simultaneous locking of more than one castor using a central activation lever. The wheel brake prevents unintended movement.



Directional lock

Directional lock for improved stability when steering around bends, as well as moving in a straight line for long distances.



Central directional lock

Simultaneous activating of the directional lock of more than one castor, through the cam via a lever.



Total lock

Total lock for simultaneously locking the wheel and swivel housing for a secure stand.



Central total lock

Simultaneous activating of the total lock of more than one castor, through the cam via a lever. Alternatively, a plate fitting with integrated central lock is available.





• **Total lock in direction of travel**

For easy access, the total lock pedal always faces in the direction of travel when pulling the application.



• **Fixed castor**

The wheel is free and the housing fixed, it cannot swivel but only move forward and backward. This allows a stable movement.



• **Fixed castor with central wheel brake**

Fixed housing with a wheel brake which can be activated via a handle. This can simultaneously brake more than one castor.



• **Fixed castor with automatic wheel lock**

The wheel is automatically locked by default. It starts rolling only when a lever or handle is activated by the user. Unintentional movement is effectively prevented.



• **Automatic directional stability 180° or 360°**

The housing is equipped with a spring for automatic alignment. Whenever the castor is picked up, it automatically aligns in the direction of travel which avoids damages and reduces maintenance costs.



• **Automatic directional stability 180° or 360° and total lock**

In addition to the automatic alignment the castor is equipped with the total lock function for a secure stand.



• **Combination total and directional lock**

The directional lock can be assembled on all swivel castors or castors with total lock in direction of travel with "P63" plate. Can be retrofitted. Available on request.



• **Automatic alignment**

The housing is equipped with a spring for automatic alignment. It is also perfect for the use of automatically guided vehicles. Whenever the castor is picked up, it automatically aligns in the direction of travel which avoids damages and reduces maintenance costs.

PRESSED STEEL HOUSINGS

Pressed steel housings are zinc plated and blue passivated.

The double ball bearing in the swivel head allows for a smooth swivel function. Alpha castors made with this pressed steel housing provide flexibility and high load capacities. This improves safety for goods and people, and increases your productivity rates at the same time.

Technical data and availability



Description	Housing type	Swivel castor	Swivel castor with central wheel brake	Swivel castor with directional lock	Swivel castor with central directional lock	Swivel castor with total lock	Swivel castor with central total lock
	Article description	3470	3479	3471	3471	3477	3476
	Material	Pressed steel	Pressed steel	Pressed steel	Pressed steel	Pressed steel	Pressed steel
	Swivel bearing	Double ball bearing	Double ball bearing	Double ball bearing	Double ball bearing	Double ball bearing	Double ball bearing
	Automatic directional stability	-	-	-	-	-	-
	Washable	-	-	-	-	-	-
	Swivel interference	Wheel ø 080 mm	160 mm	160 mm	246 mm	-	246 mm
Wheel ø 100 mm		180 mm	180 mm	246 mm	180 mm	246 mm	-
Wheel ø 108 mm		186 mm	-	-	-	-	-
Wheel ø 125 mm		205 mm	205 mm	246 mm	205 mm	246 mm	235 mm
Wheel ø 160 mm		270 mm	-	-	-	334 mm	270 mm
Wheel ø 200 mm		310 mm	-	-	-	334 mm	310 mm

Items marked with this sign "—" are not available in our standard range. Please contact us. Items with this sign "●" are available.



Retrofittable directional lock

The directional lock can be assembled on all swivel castors or castors with total lock in direction of travel with "P63" plate. Available on request.

Swivel bearing

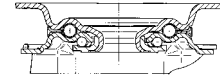

Double ball bearing for good manoeuvrability.



Swivel castor with central total lock	Swivel castor with total lock in direction of travel	Fixed castor	Fixed castor with central wheel brake	Fixed castor with automatic wheel brake	Swivel castor with automatic directional stability 180° or 360°		Swivel castor with automatic directional stability 180° or 360° and total lock	
3476	3472	3478	3499	349D	347S		347B	
Pressed steel	Pressed steel	Pressed steel	Pressed steel	Pressed steel	Pressed steel		Pressed steel	
Double ball bearing	Double ball bearing	-	-	-	Double ball bearing		Double ball bearing	
-	-	-	-	-	180°	360°	180°	360°
-	-	-	-	-	-	-	-	-
-	-	●	-	-	160 mm	160 mm	246 mm	246 mm
-	-	●	-	-	180 mm	180 mm	246 mm	246 mm
-	-	●	-	-	-	-	-	-
-	-	●	-	-	205 mm	205 mm	246 mm	246 mm
270 mm	270 mm	●	●	●	270 mm	-	334 mm	-
310 mm	310 mm	●	●	●	310 mm	-	334 mm	-

STAINLESS STEEL HOUSINGS

Castors made of stainless steel have a very high resistance to external elements such as water, humidity, various acids, fats and strong cleaning agents. Thanks to their corrosion resistance, the castors have a long service life and can be used within a wide temperature range. In addition, the castors are washable which is important in industries where hygiene is top priority.

Technical data and availability



Description	Housing type	Swivel castor	Swivel castor with directional lock, retrofitted	Swivel castor with total lock	Swivel castor with central total lock
	Article description	8470	8471	8477	8476
	Material	Stainless steel	Stainless steel	Stainless steel	Stainless steel
	Swivel bearing	Double ball bearing	Double ball bearing	Double ball bearing	Double ball bearing
	Automatic directional stability	-	-	-	-
	Washable*	●	●	●	●
Swivel interference	Wheel ø 080 mm	160 mm	-	246 mm	-
	Wheel ø 100 mm	180 mm	-	246 mm	-
	Wheel ø 108 mm	186 mm	-	-	-
	Wheel ø 125 mm	205 mm	246 mm	246 mm	-
	Wheel ø 160 mm	270 mm	270 mm	334 mm	270 mm
	Wheel ø 200 mm	310 mm	310 mm	334 mm	310 mm

Items marked with this sign "-" are not available in our standard range. Please contact us. Items with this sign "●" are available.

*Washable versions with metal components made of stainless steel.



Retrofittable directional lock

The directional lock can be assembled on all swivel castors.. Available on request.

Swivel bearing

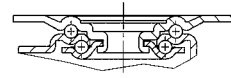

Double ball bearing for good manoeuvrability.



Fixed castor	Fixed castor with central wheel brake	Fixed castor with automatic wheel brake	Swivel castor with automatic directional stability 180° or 360°		Swivel castor with automatic directional stability 180° or 360° and total lock	
8478	8499	849D	847S		847B	
Stainless steel	Stainless steel	Stainless steel	Stainless steel		Stainless steel	
-	-	-	Double ball bearing		Double ball bearing	
-	-	-	180°	360°	180°	360°
●	●	●	●	●	●	●
●	-	-	160 mm	160 mm	246 mm	246 mm
●	-	-	180 mm	180 mm	246 mm	246 mm
●	-	-	-	-	-	-
●	-	-	205 mm	205 mm	246 mm	246 mm
●	●	●	270 mm	-	334 mm	-
●	●	●	310 mm	-	334 mm	-

WHEELS

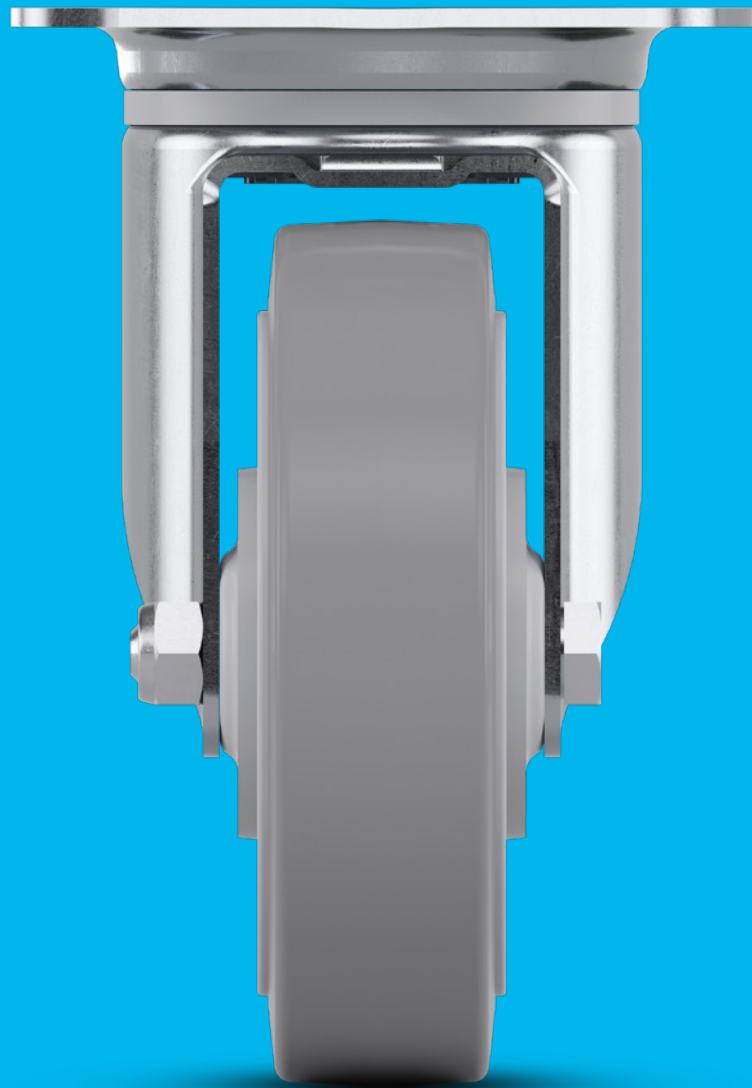

FEATURES



Quiet rolling

Noise reduced wheel options to suit a quiet work environment.



Non-marking movement

Wheels with reduced abrasion and little cleaning requirement.

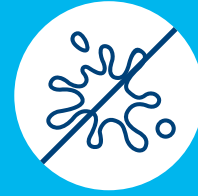

Non-staining operation

Non-staining on contact with floors when standing for long periods.



Low-maintenance wheels

Thread-guards for unobstructed operation with minimal cleaning effort.

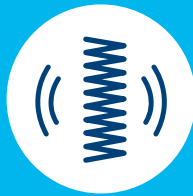

Low vibration transport

Extra soft wheels with good shock-absorbing properties.



Protective seal

Wheels with sealed bearings to protect against spray water and dirt.



Low wear and tear wheels

Durable wheels with extremely low wear and tear.



Ergonomically friendly use

Wheels with optimised roll resistance to lighten the load for the user.

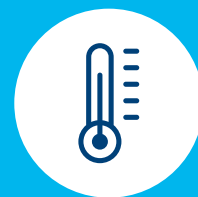

Constant heat resistance

Wheels made of heat resistant material for use in extreme environments.

WHEELS

The characteristics of a wheel depend on the type of bearing and the materials used. Wheels are also available in different levels of hardness. We can guarantee maximum manoeuvrability and quiet operation, with a variety of treads.

The materials are tested in our own laboratory to ensure they comply with European standards. Non-hazardous materials are used in order to comply with RoHS and REACH regulations.



Duratech

Stable and indestructible, made of polyamide and thermosetting plastic with an abrasion-resistant tread.



Basetech

Hard-wearing and washable lightweight polypropylene wheels. The low maintenance wheels are chemical resistant.

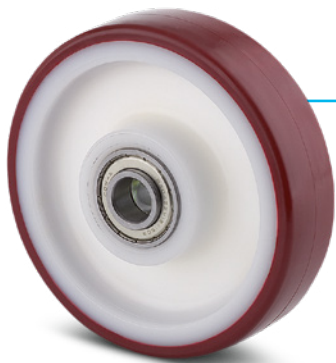

Maxtech

Perfect for functional design made of injection moulded polyurethane.



• **Novatech**

Highly resilient classics with cast polyurethane coating. The shore hardness of the tread and the shape can be customised. Use convex treads for added manoeuvrability or flat tread for better traction.



• **Puretech**

Robust standard rubber tread for versatile use. Protection through low-vibration transport.



• **Supratech**

Smooth running, all-rounder with thermoplastic rubber tread. Excellent manoeuvrability due to the use of high-performance material.



• **Elastech**

Quiet-running elastic and silicon rubber for smoothest handling properties.

Technical data and availability



i		Duratech	Duratech silent	Duratech heat	Basetech
Description	Product name				
	Article description	UOO, UOR, UOP, UOC, UOD, XOR, XOP	HUR, UOT	BOG	POO, POR, POJ, PQR
	Tread material	Polyamide	Polyamide	Heat resisting synthetic material	Polypropylene
	Tread hardness	Shore D 75	Shore D 75	Shore D 85	Shore D 65
	Wheel body material	Polyamide	Polyamide	Heat resisting synthetic material	Polypropylene
	Temperature range	- 40 °C / + 80 °C	HUR - 20 °C / + 60 °C UOT - 40 °C / + 80 °C	- 40 °C / + 280 °C	- 20 °C / + 60 °C
	Tread width	34 - 50 mm	36 - 40 mm	35 mm	34 - 40 mm
	Antistatic	-	-	-	-
	Electric conductive (10 ⁴ OHM)	● XOR, XOP	-	-	-
	Washable*	● UOC, UOD	-	-	-
Bearing type	Plain bearing	●	-	● self-lubricating	●
	Roller bearing	●	● HUR	-	●
	Precision ball bearing	●	● UOT	-	●
Load capacity	Wheel Ø 080 mm	180 - 200 kg	-	100 kg	125 kg
	Wheel Ø 100 mm	200 - 250 kg	160 - 250 kg	125 kg	160 kg
	Wheel Ø 125 mm	250 - 350 kg**	200 - 250 kg	-	200 kg
	Wheel Ø 160 mm	350 - 500 kg***	-	-	-
	Wheel Ø 200 mm	350 - 500 kg***	-	-	-

Items marked with this sign "-" are not available in our standard range. Please contact us. Items with this sign "●" are available.

The mentioned load capacity applies only to the Alpha product family. The load capacity of the wheel alone, without housing, could be different.

* Washable wheels with bearings made of stainless steel.

** 300 - 350 kg load capacity with P63 fitting.

*** 500 kg load capacity with housing 8470.



Maxtech
UAC, UAD, UAR, UAP, XSP, XSX, XSC
Polyurethane
Shore D 40
Polyurethane
- 40 °C / + 80 °C
32 - 50 mm
-
● XSP, XSX, XSC
● XSC, UAD
-
●
●
100 - 150 kg
150 kg
200 - 300 kg**
350 - 500 kg***
350 - 500 kg***

Bearing types



Plain bearing



Roller bearing



Precision ball bearing



Load capacity

The load capacity depends on the housing and wheel. It has been tested and fulfills the requirements according to EN 12532 at a speed of 4 km/h. When using four castors, you can calculate the necessary load capacity as follows: The sum of the weight of your application plus the additional load divided by three castors.

$$\frac{\text{Weight of application} + \text{load}}{3} = \text{Load capacity of one castor}$$

Technical data and availability



i		Novatech	Novatech soft	Puretech	Supratech
Description	Product name	Novatech	Novatech soft	Puretech	Supratech
	Article description	ITP	ITP soft	DIR, DVR, PVO, PVR, PIO, PIR	PJO, PJR, PJP, XSP, XSC
	Tread material	Polyurethane, casted	Polyurethane, casted	Rubber	Thermoplastic rubber
	Tread hardness	A 92	A 80	A 85	A 87
	Wheel body material	Aluminum	Aluminum	Polypropylene	Polypropylene
	Temperature range	- 20 °C / + 60 °C	- 20 °C / + 60 °C	- 20 °C / + 60 °C	- 20 °C / + 60 °C
	Tread width	30 - 50 mm	50 mm	35 - 60 mm	32 - 40 mm
	Antistatic	●	●	-	-
	Electric conductive (10 ⁴ OHM)	-	-	-	● XSP
	Washable*	-	-	-	● XSC
Bearing type	Plain bearing	-	-	●	●
	Roller bearing	-	-	●	●
	Precision ball bearing	●	●	-	●
Load capacity	Wheel Ø 080 mm	-	-	70 kg	-
	Wheel Ø 100 mm	250 kg	-	75 kg	80 - 100 kg
	Wheel Ø 125 mm	250 - 350 kg**	350 kg**	100 kg	100 kg
	Wheel Ø 160 mm	350 kg	350 kg	135 kg	160 kg
	Wheel Ø 200 mm	350 kg	350 kg	205 kg	160 kg

Items marked with this sign "-" are not available in our standard range. Please contact us. Items with this sign "●" are available.

The mentioned load capacity is only valid for the Alpha product family. The load capacity of the wheel alone, without housing, could be different.

* Washable wheels with bearings made of stainless steel.

** 350 kg load capacity with P63 fitting.



HEAT
RESISTANT

Supratech plus	Elastech	Elastech heat	Elastech plus
PJP	UER, UEP, UFR, UFP, UFD, UFC, UFX	IDC, IDG	IEP, IFP, ILP, IYP
Thermoplastic rubber	Elastic rubber	Heat resisting silicone rubber	Elastic rubber
A 65	A 64	A 75	A 64
Polypropylene	Polyamide	Aluminum	Aluminum
- 20 °C / + 60 °C	- 20 °C / + 80 °C	- 30 °C / + 250 °C	- 20 °C / + 80 °C
35 - 45 mm	34 - 46 mm	35 mm	40 - 55 mm
-	-	-	● ILP
-	-	-	● IYP
-	● UFD, UFC	-	-
-	-	● self-lubricating	-
-	●	-	-
●	●	●	●
-	-	-	-
110 kg	160 kg	80 kg	-
180 kg	250 kg	-	300 kg
200 kg	300 kg	-	350 kg
250 kg	400 kg	-	350 kg

Bearing types



Plain bearing

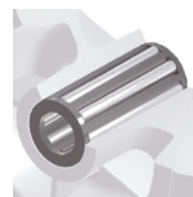

Roller bearing



Precision ball bearing



Load capacity

The load capacity depends on the housing and wheel. It has been tested and fulfills the requirements according to EN 12532 at a speed of 4 km/h. When using four castors, calculate the necessary load capacity as follows: The sum of the weight of your application plus the additional load divided by three castors.

$$\frac{\text{Weight of application} + \text{load}}{3} = \text{Load capacity of one castor}$$

FITTINGS



FEATURES



User-friendly central lock

Simultaneous locking of more than one castor at a time using an activation lever.

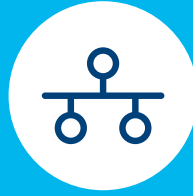

Practical system solution

Practical system solution with all technical components for central locking.

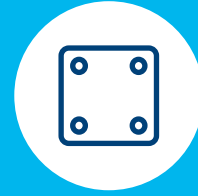

Variable fitting options

Different fitting options for a large range of applications.

ADDITIONAL FEATURES



Tested quality

Tested in our own test laboratory for compliance with European standards.

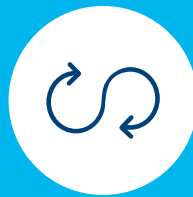

Uninterrupted use

Swivel bearing with dust ring for continuous, uninterrupted movement.



Non-hazardous materials

Complies with the RoHS directive and REACH regulation of the European Union. Does not contain polycyclic aromatic hydrocarbons or chromium (VI).

PLATE FITTINGS

Secure connection with four screws. The castor is mounted using nuts and bolts to a flat surface on the equipment.



Technical data and availability

					
Description	Fitting type	Swivel plate	Fixed plate	Swivel plate	Fixed plate
	Article description	P62	P62	P63	P63
	Size of plate	105 x 80 mm	103 x 85 mm	137 x 105 mm	137 x 115 mm
	Plate hole centres	80/77 x 60 mm	80/77 x 60 mm	105 x 80/75 mm	105 x 80/75 mm
	Plate hole \varnothing	9 mm	9 mm	11 mm	11 mm
Overall height	Wheel \varnothing 080 mm	108 mm	108 mm	-	-
	Wheel \varnothing 100 mm	128 mm	128 mm	128 mm	125 mm
	Wheel \varnothing 108 mm	132 mm	132 mm	-	-
	Wheel \varnothing 125 mm	155 mm	155 mm	161 mm	161 mm
	Wheel \varnothing 160 mm	-	-	200 mm	200 mm
	Wheel \varnothing 200 mm	-	-	240 mm	240 mm

Items with this sign "-" are not available in our standard range. Please contact us.



Plate with integrated central lock

The brake pedal is already attached to the mounting plate. Because the swivel mechanism is independent of the mounting plate, the break pedal is always in the same position and easy to reach.



Plate with integrated central total lock	Plate with integrated central wheel lock	Plate with integrated central total lock
P67	P69	P70
137 x 105 mm	137 x 105 mm	105 x 80 mm
105 x 80/75 mm	105 x 80/75 mm	80/77 x 60 mm
11 mm	11 mm	9 mm
-	-	-
-	-	128 mm
-	-	155 mm
-	-	-
200 mm	200 mm	-
240 mm	240 mm	-

BOLT HOLE FITTINGS

A bolt hole offers the option to fix the application to the castor with a standard screw M10 or M12. Screws of any length can be used.



Technical data and availability



Description	Fitting type	Single bolt hole	Single bolt hole
	Article description	P30	P30
	Bolt hole \varnothing	11 mm	13 mm
Overall height	Wheel \varnothing 80 mm	108 mm	108 mm
	Wheel \varnothing 100 mm	128 mm	128 mm
	Wheel \varnothing 125 mm	155 mm	155 mm
	Wheel \varnothing 160 mm	195 mm	195 mm
	Wheel \varnothing 200 mm	235 mm	235 mm

EXPANDING FITTINGS FOR TUBES

For an easy mounting into tubes, we offer for bolt hole fittings in diameter 11 mm suitable expanding fittings. The adjustable expanders allow for flexible installation in different tube sizes.

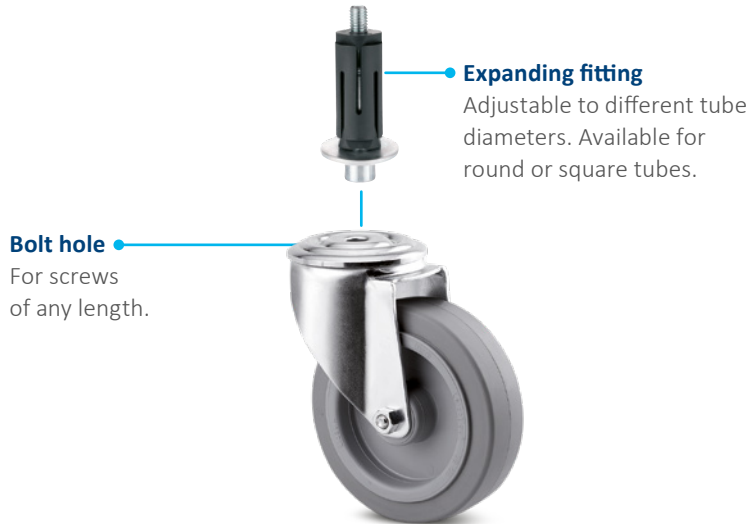

Technical data and availability



Description	Fitting type	Expander, round	Expander, square
	Article description	R07	R47
	Expander measurements	Ø 19 - 21,5 mm Ø 21,5 - 24 mm Ø 24 - 27 mm Ø 27 - 30 mm Ø 31 - 35 mm	Ø 21,5 - 24 mm Ø 24 - 27 mm Ø 27 - 30 mm Ø 32 - 35 mm Ø 36 - 40 mm
Overall height	Wheel Ø 80 mm	●	●
	Wheel Ø 100 mm	●	●
	Wheel Ø 125 mm	●	●
	Wheel Ø 160 mm	-	-
	Wheel Ø 200 mm	-	-

Items marked with this sign "-" are not available in our standard range. Please contact us.
 Items with this sign "●" are available.



SOLID STEM FITTINGS

These types of fittings are very quick and easy to attach. They can be fixed in a tube with a screw or threaded pin, for example.



Technical data and availability



 Description	Fitting type	Solid stem
	Article description	R05
	Thread for set screw	M8
	Thread position from bottom	19 mm
	Solid stem \varnothing	28 mm
	Solid stem length	45 mm
 Overall height	Wheel \varnothing 80 mm	-
	Wheel \varnothing 100 mm	-
	Wheel \varnothing 125 mm	158 mm
	Wheel \varnothing 160 mm	195 mm
	Wheel \varnothing 200 mm	235 mm

Items with this sign "-" are not available in our standard range. Please contact us.

ACCESSORIES

We offer all technical components for central locking.

Profile bar for central locking



Description	i Article description	Profile bar
	Material	Steel
	Lengths	Up to 3 m
	Profile bar	11 mm hex
	Adjustment range of the brake pad	10 mm



Example of mounted central locking components

Foot pedal for central locking



Description	i Article description	Foot pedal
	Compatible with	Profile bar
	Material	Steel
	Measurements	70 x 94 mm

DIVERSITY WITH A SYSTEM

OUR CASTORS

All of our products have their own specific qualities and strengths. Whether it's high design standards, specialist applications or exceptional load capacities – our range can meet your needs and can be adapted to fit different models.

From the correct dimensions and technical specifications to the required configuration, our product families are able to offer the ideal solution – whatever you need. Contact us for more information or visit our website: www.tente.com

E-Drive

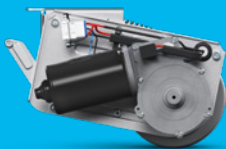

⌀ 125 mm

Alpha



⊃ 70 - 500 kg
⌀ 80 - 200 mm

Delta



⊃ 300 - 600 kg
⌀ 125 - 200 mm

Delta twin



⊃ 600 - 750 kg
⌀ 125 - 200 mm

Zeta



⊃ 300 - 800 kg
⌀ 125 - 250 mm

Kappa



⊃ 300 - 2.000 kg
⌀ 80 - 300 mm

Kappa flex



⊃ 360 - 750 kg
⌀ 160 - 200 mm

Omikron



⊃ 900 - 11.000 kg
⌀ 100 - 500 mm

Radiata

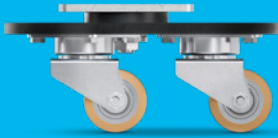

1.200 - 1.500 kg
80 mm

Scout



150 - 350 kg
160 - 200 mm

Integral



100 - 150 kg
100 - 200 mm

Integral twin



125 - 250 kg
100 - 150 mm

Linea clinic



150 - 200 kg
125 - 150 mm

Aviana care



100 kg
75 mm

Aviana



75 mm

Agila



40 - 100 kg
50 - 150 mm

Agila twin



50 - 100 kg
50 - 75 mm

Stora



60 - 160 kg
75 - 160 mm

Mono



30 - 70 kg
50 - 100 mm

Galea



60 - 100 kg
100 - 125 mm

Levina



60 - 100 kg
75 - 150 mm

Linea



40 - 150 kg
50 - 150 mm

Anika



40 - 50 kg
55 - 75 mm

Lumina



30 - 100 kg
35 - 75 mm

Stylea



40 - 100 kg
35 - 100 mm

Smiles



40 kg
50 mm

Compacta



10 - 55 kg
14 - 50 mm

EXPERTISE THAT INSPIRES

CONTACT US

We are a globally operating company supporting you on five continents. This means on-site support with service on a level playing field – along with in-depth knowledge. Additionally, our solution experts will advise you on the best mobility concept for your needs. Go here to find your nearest TENTE location: www.tente.com/locations

INCREASE YOUR EFFICIENCY

Our intelligent mobility solutions help you save time, effort, energy, and operating expenses. This allows you to improve your operating methods and working conditions, thereby optimising your processes and ensuring higher productivity, profitability and safety. Ask for our solutions catalogue or read about how our customers benefit from our tailor-made solutions on our website: www.tente.com/solutions

SAVE DEVELOPMENT TIME

On our website you will find technical drawings, product data sheets and 2D and 3D CAD files in various formats: www.tente.com/alpha

GET MORE INFORMATION

In addition to our informative website, you can easily download various catalogues and brochures on mobility solutions, customer references, and much more: www.tente.com/download



ER LIFE.

ET

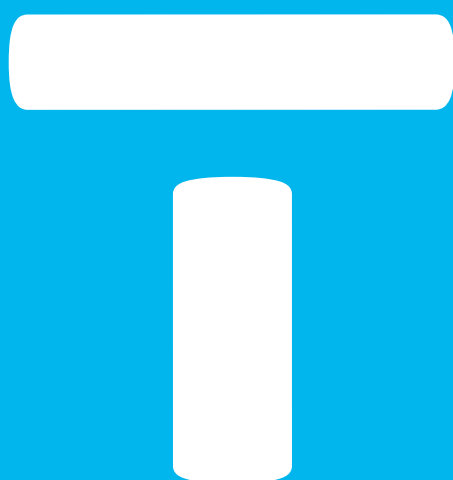

www.tente.com



PRODUCTIVITY



SAFETY



DESIGN



DURABILITY



ENVIRONMENT