

OMIKRON

9250STP300P66

EAN 4031582314052

Swivel castor, housing and plate steel-welded, zinc plated, blue passivated, sealed swivel bearing with dual purpose bearing and tapered roller bearing, threaded king pin and locking nut secured, grease nipple, wheel axle with nut, plate fitting. Wheel centre made of pressed steel, lacquered, heavy duty, Tread: Polyurethane, casted, precision ball bearing



BETTER MOBILITY. BETTER LIFE.



Picture may differ from original product

Technical Data

Wheel diameter	300 mm
Wheel width	100 mm
Size of Plate	250 x 200 mm
Plate hole centres	210 x 160 mm
Plate hole	17 mm
Offset	90 mm
Swivel Interference	480 mm
Overall height	370 mm
Temperature	- 20 / + 60 °C
Standard	EN_12533
Weight	42.031 kg
Swivel Radius	240 mm
Hardness of tread	Shore A 92
Load capacity	2600 kg
Load capacity (static)	5200 kg

Advantages at a glance

Roll performance	● ● ● ○ ○
Movement noise	● ● ● ○ ○
Attrition	● ● ● ● ○
Corrosion resistance	● ● ● ○ ○

Dimensions

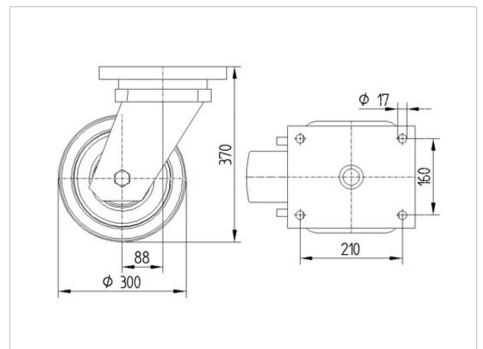

Structure & Mounting

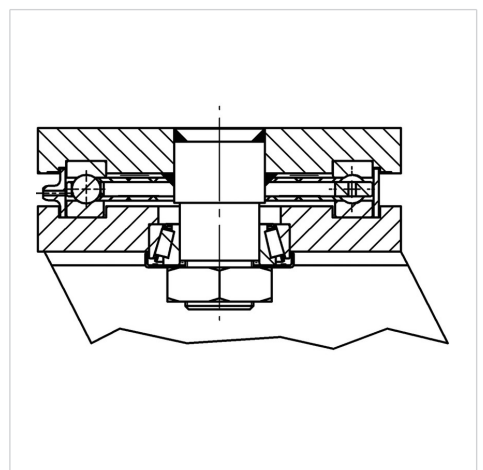

OMIKRON

9250STP300P66

EAN 4031582314052



BETTER MOBILITY. BETTER LIFE.

Structure & Mounting

