

# SUPRATECH

PJR100x32-Ø12 HL34,9

EAN 4031582320510

Wheel centre made of Polypropylene, Tread: TENTEprene (thermoplastic rubber), non-marking, roller bearing



BETTER MOBILITY. BETTER LIFE.



Picture may differ from original product

## Technical Data

Wheel diameter	100 mm
Wheel width	32 mm
Axle Hole-Ø	12 mm
Hub length	34.9 mm
Temperature	- 20 / + 60 °C
Standard	EN_12530
Weight	0.156 kg
Hardness of tread	Shore A 87
Load capacity	100 kg
Load capacity (static)	200 kg

## Dimensions

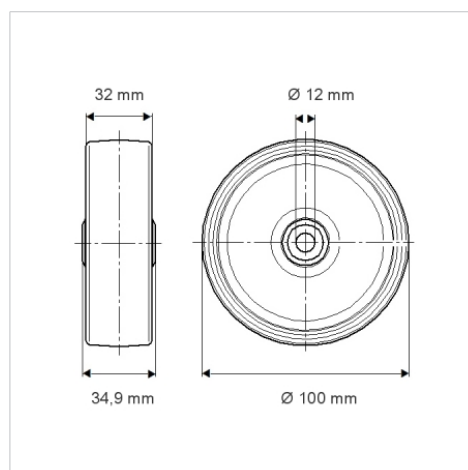

## Advantages at a glance

Roll performance	● ● ● ○ ○
Movement noise	● ● ● ○ ○
Attrition	● ● ● ○ ○
Corrosion resistance	● ● ● ○ ○