

BASETECH

POO065x30-Ø12

EAN 4031582418965

Wheel centre made of Polypropylene, plain bearing



BETTER MOBILITY. BETTER LIFE.



Picture may differ from original product

Technical Data

Wheel diameter	65 mm
Wheel width	30 mm
Axle Hole-Ø	12 mm
Hub length	34.5 mm
Temperature	- 20 / + 60 °C
Standard	EN_12532
Weight	0.047 kg
Hardness of tread	Shore D 65
Load capacity	120 kg
Load capacity (static)	240 kg

Dimensions

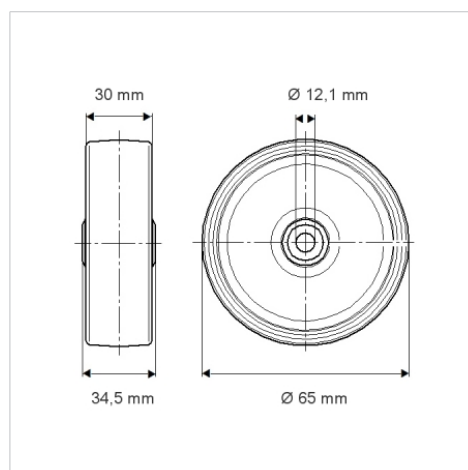

Advantages at a glance

Roll performance	● ● ● ○ ○
Movement noise	● ● ● ○ ○
Attrition	● ● ● ● ●
Corrosion resistance	● ● ● ○ ○