

# BASETECH

POO125x40-Ø12

EAN 4031582418996

Wheel centre made of Polypropylene, plain bearing



BETTER MOBILITY. BETTER LIFE.



Picture may differ from original product

## Technical Data

Wheel diameter	125 mm
Wheel width	40 mm
Axle Hole-Ø	12 mm
Hub length	44.4 mm
Temperature	- 20 / + 60 °C
Standard	EN_12530
Weight	0.177 kg
Hardness of tread	Shore D 65
Load capacity	200 kg
Load capacity (static)	400 kg

## Dimensions

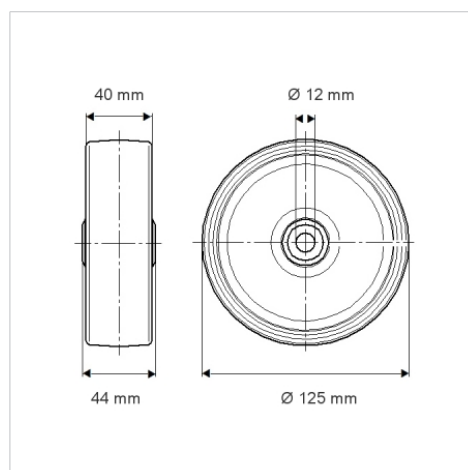

## Advantages at a glance

Roll performance	● ● ● ○ ○
Movement noise	● ● ● ○ ○
Attrition	● ● ● ● ●
Corrosion resistance	● ● ● ○ ○