

BASETECH

POO075x25-Ø8

EAN 4031582320725

Wheel centre made of Polypropylene, plain bearing



BETTER MOBILITY. BETTER LIFE.



Picture may differ from original product

Technical Data

Wheel diameter	75 mm
Wheel width	25 mm
Axle Hole-Ø	8 mm
Hub length	26.5 mm
Temperature	- 20 / + 60 °C
Standard	EN_12530
Weight	0.045 kg
Hardness of tread	Shore D 65
Load capacity	50 kg
Load capacity (static)	100 kg

Dimensions

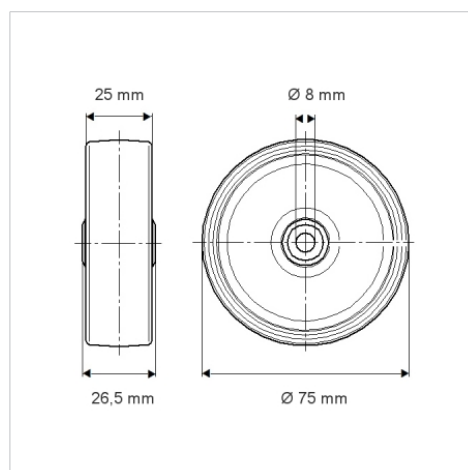

Advantages at a glance

Roll performance	● ● ● ○ ○
Movement noise	● ● ● ○ ○
Attrition	● ● ● ● ●
Corrosion resistance	● ● ● ○ ○