

ZETA

4687IEP125P63

EAN 4031582308112

Swivel castor with total lock, tail end of castor, housing made of very heavy pressed steel, reinforced, bright zinc plated, blue passivated, sealed swivel double ball bearing, reinforced and heat-treated ball covers, riveted king pin, dust ring with integrated grease nipple, wheel axle with nut, plate fitting. Wheel centre made of Aluminium, Tread: black elastic-tyre, vulcanized, precision ball bearing



BETTER MOBILITY. BETTER LIFE.



Picture may differ from original product

Technical Data

Wheel diameter	125 mm
Wheel width	50 mm
Castor width	96 mm
Size of Plate	137 x 105 mm
Plate hole centres	105 x 80/75 mm
Plate hole	11 mm
Dome-Ø	96 mm
Offset	60 mm
Swivel Interference	322 mm
Overall height	164 mm
Temperature	- 20 / + 85 °C
Standard	EN_12532
Weight	3.175 kg
Swivel Radius	161 mm
Hardness of tread	Shore A 67
Load capacity	300 kg
Load capacity (static)	600 kg

Advantages at a glance

Roll performance	● ● ● ○ ○
Movement noise	● ● ● ○ ○
Attrition	● ● ● ○ ○
Corrosion resistance	● ● ● ○ ○

Dimensions

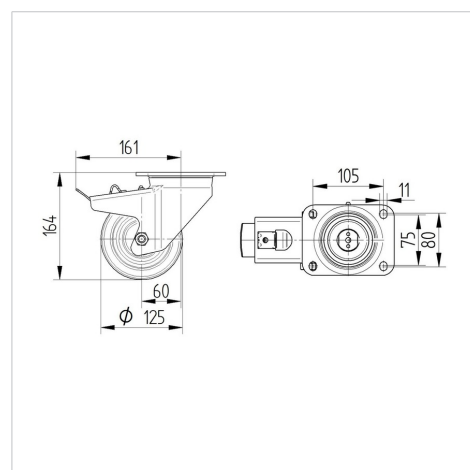

Structure & Mounting

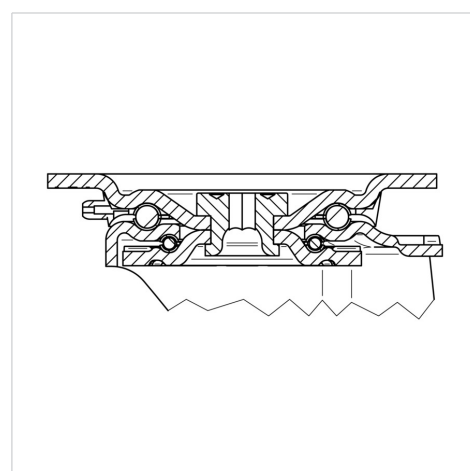

ZETA

4687IEP125P63

EAN 4031582308112



BETTER MOBILITY. BETTER LIFE.

Structure & Mounting

