

PURETECH

DIK125x32-Ø8

EAN 4031582070163

Wheel centre made of pressed steel, Tread: solid rubber, grey non-marking, with threadguards, cone ball bearing



BETTER MOBILITY. BETTER LIFE.



Picture may differ from original product

Technical Data

Wheel diameter	125 mm
Wheel width	32 mm
Axle Hole-Ø	8 mm
Hub length	36 mm
Temperature	- 20 / + 85 °C
Standard	EN_12530
Weight	0.614 kg
Hardness of tread	Shore A 80
Load capacity	100 kg
Load capacity (static)	200 kg

Dimensions

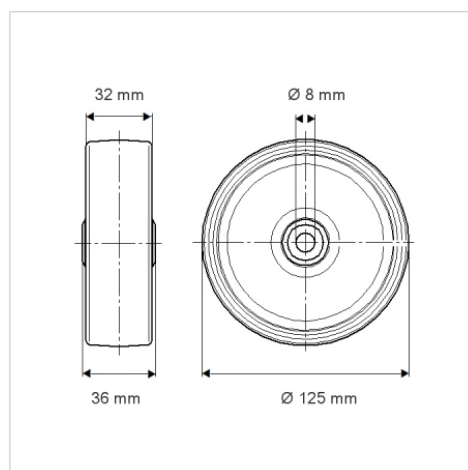

Advantages at a glance

Roll performance	● ● ● ○ ○
Movement noise	● ● ● ○ ○
Attrition	● ● ● ○ ○
Corrosion resistance	● ● ● ○ ○