

DURATECH

U00050x20-Ø8

EAN 4031582323450

Wheel centre made of Polyamide, plain bearing



BETTER MOBILITY. BETTER LIFE.



Picture may differ from original product

Technical Data

Wheel diameter	50 mm
Wheel width	20 mm
Axle Hole-Ø	8.1 mm
Hub length	21.7 mm
Temperature	- 40 / + 80 °C
Standard	EN_12530
Weight	0.018 kg
Hardness of tread	Shore D 75
Load capacity	55 kg
Load capacity (static)	110 kg

Dimensions

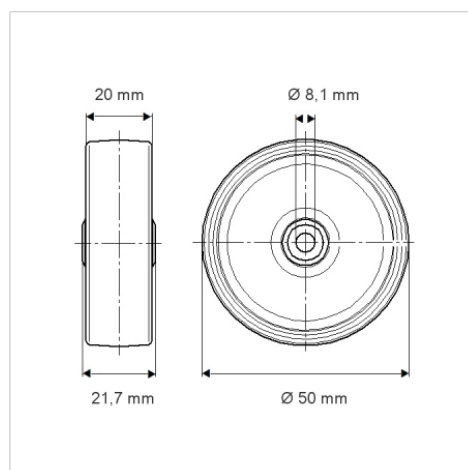

Advantages at a glance

Roll performance	● ● ● ○ ○
Movement noise	● ● ● ○ ○
Attrition	● ● ● ● ●
Corrosion resistance	● ● ● ○ ○