

DELTA TWIN

9940UOP200P63

EAN 4031582366938

Swivel castor, housing made of heavy pressed steel, bright zinc plated, blue passivated, precision ball bearing swivel head, sealed, wheel axle with nut, plate fitting. Wheel centre made of Polyamide, precision ball bearing



BETTER MOBILITY. BETTER LIFE.



Picture may differ from original product

Technical Data

Wheel diameter	200 mm
Wheel width	50 mm
Castor width	157 mm
Size of Plate	137 x 105 mm
Plate hole centres	105 x 80/75 mm
Plate hole	11 mm
Dome-Ø	136 mm
Offset	55 mm
Swivel Interference	323 mm
Overall height	250 mm
Temperature	- 40 / + 85 °C
Standard	EN_12532
Weight	5.17 kg
Swivel Radius	161.5 mm
Hardness of tread	Shore D 75
Load capacity	750 kg
Load capacity (static)	1500 kg

Advantages at a glance

Roll performance	● ● ● ○ ○
Movement noise	● ● ● ○ ○
Attrition	● ● ● ● ○
Corrosion resistance	● ● ● ○ ○

Dimensions

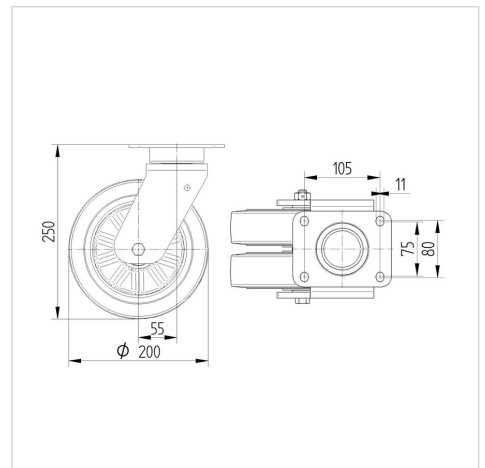

Structure & Mounting

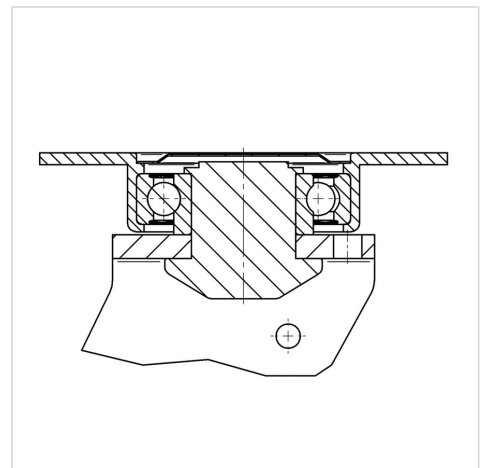

DELTA TWIN

9940UOP200P63

EAN 4031582366938



BETTER MOBILITY. BETTER LIFE.

Structure & Mounting

