

NOVATECH

STP250x100-Ø35 HL120

EAN 4031582322231

Wheel centre made of pressed steel, lacquered, heavy duty, Tread: Polyurethane, casted, precision ball bearing



BETTER MOBILITY. BETTER LIFE.



Picture may differ from original product

Technical Data

Wheel diameter	250 mm
Wheel width	100 mm
Axle Hole-Ø	35 mm
Hub length	120 mm
Temperature	- 10 / + 60 °C
Standard	EN_12533
Weight	18.321 kg
Hardness of tread	Shore A 92
Load capacity	2200 kg
Load capacity (static)	4400 kg

Dimensions

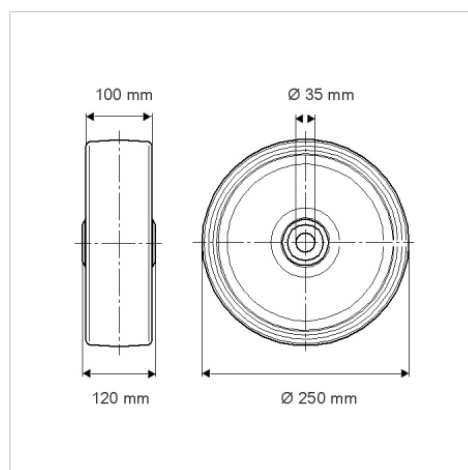

Advantages at a glance

Roll performance	● ● ● ○ ○
Movement noise	● ● ● ○ ○
Attrition	● ● ● ● ○
Corrosion resistance	● ● ● ○ ○

Structure & Mounting

