

STYLEA

5923UOI065B10-11x20 DOM23

EAN 4031582311044

Swivel castor with intermittend brake, housing made of Polyamide, stem with circlip. Wheel centre made of Polyamide, plain bearing



BETTER MOBILITY. BETTER LIFE.



Picture may differ from original product

Technical Data

Wheel diameter	65 mm
Wheel width	8 mm
Castor width	43 mm
Metal stem with circlip	11 x 20 mm
Dome-Ø	23 mm
Offset	25 mm
Swivel Interference	106 mm
Overall height	68 mm
Temperature	- 20 / + 60 °C
Standard	EN12529
Weight	0.127 kg
Swivel Radius	53 mm
Hardness of tread	Shore D 65
Load capacity	50 kg
Load capacity (static)	100 kg

Structure & Mounting

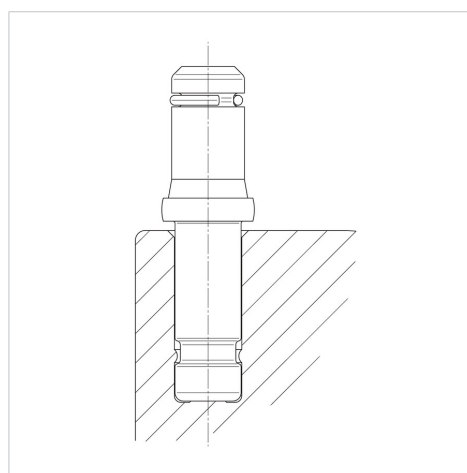

Advantages at a glance

Roll performance	● ● ● ○ ○
Movement noise	● ● ● ○ ○
Attrition	● ● ● ● ●
Corrosion resistance	● ● ● ● ○