

# LINEA

5941UAP125R05-28 RAL9002

EAN 4031582369199

Swivel castor with directional lock, housing made of Polyamide, precision ball bearing in swivel head, solid plug fitting. Wheel centre made of Polyamide, Tread: Polyurethane, precision ball bearing



BETTER MOBILITY. BETTER LIFE.



Picture may differ from original product

## Technical Data

Wheel diameter	125 mm
Wheel width	20 mm
Castor width	82 mm
Bolt-Ø	28 mm
Bolt length	40 mm
Dome-Ø	52 mm
Offset	40 mm
Swivel Interference	258 mm
Overall height	145 mm
Temperature	- 10 / + 40 °C
Standard	EN_12530
Weight	1.078 kg
Swivel Radius	129 mm
Hardness of tread	Shore A 92
Load capacity	130 kg
Load capacity (static)	260 kg

## Advantages at a glance

Roll performance	● ● ● ● ●
Movement noise	● ● ● ○ ○
Attrition	● ● ● ● ○
Corrosion resistance	● ● ● ● ○

## Dimensions

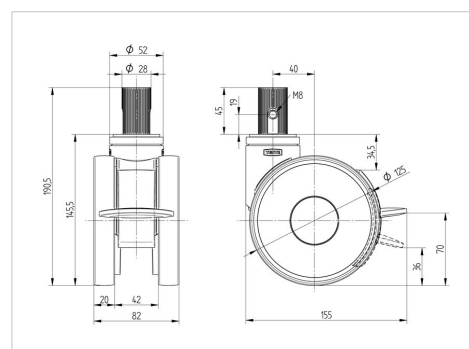

## Structure & Mounting

