

ZETA

4688IEP200P63

EAN 4031582308273

Fixed castor, Fork made of heavy pressed steel, reinforced, bright zinc plated, blue passivated, wheel axle with nut, plate fitting.
Wheel centre made of Aluminium, Tread: black elastic-tyre, vulcanized, precision ball bearing



BETTER MOBILITY. BETTER LIFE.



Picture may differ from original product

Technical Data

Wheel diameter	200 mm
Wheel width	50 mm
Castor width	117 mm
Size of Plate	137 x 117 mm
Plate hole centres	105 x 80/75 mm
Plate hole	11 mm
Overall height	240 mm
Temperature	- 20 / + 85 °C
Standard	EN_12532
Weight	2.941 kg
Hardness of tread	Shore A 67
Load capacity	450 kg
Load capacity (static)	900 kg

Dimensions

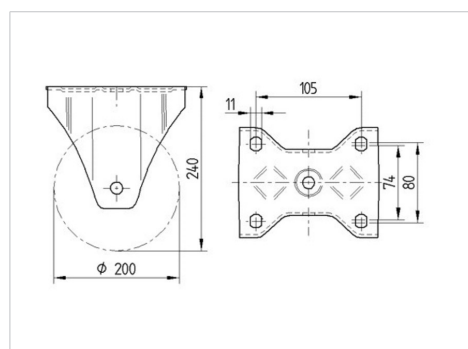

Advantages at a glance

Roll performance	● ● ● ○ ○
Movement noise	● ● ● ○ ○
Attrition	● ● ● ○ ○
Corrosion resistance	● ● ● ○ ○

ZETA

4688IEP200P63

EAN 4031582308273



BETTER MOBILITY. BETTER LIFE.

Structure & Mounting

