

MONO

5020PJH100L51-10 RAL7035

EAN 4031582308419

Swivel castor, housing made of Polyamide, with blind hole fitting. Wheel centre made of Polypropylene, Tread: TENTEprene (thermoplastic rubber), grey non-marking, with threadguards, plain bearing



BETTER MOBILITY. BETTER LIFE.



Picture may differ from original product

Technical Data

Wheel diameter	100 mm
Wheel width	24 mm
Centre hole	10 mm
Offset	40 mm
Swivel Interference	180 mm
Overall height	120 mm
Temperature	- 20 / + 60 °C
Standard	EN_12528
Weight	0.2 kg
Swivel Radius	90 mm
Hardness of tread	Shore A 90
Load capacity	70 kg
Load capacity (static)	140 kg

Structure & Mounting

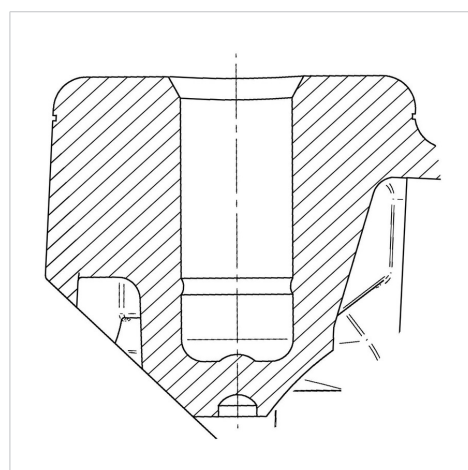

Advantages at a glance

Roll performance	● ● ● ○ ○
Movement noise	● ● ● ○ ○
Attrition	● ● ● ○ ○
Corrosion resistance	● ● ● ● ○