

# MONO

A020PJH080L51-10 RAL9006

EAN 4031582317114

Swivel castor, housing made of Polypropylene, with blind hole fitting.  
Wheel centre made of Polypropylene, Tread: TENTEprene (thermoplastic rubber), grey non-marking, with threadguards, plain bearing



BETTER MOBILITY. BETTER LIFE.



Picture may differ from original product

## Technical Data

Wheel diameter	80 mm
Wheel width	24 mm
Centre hole	10 mm
Offset	34 mm
Swivel Interference	148 mm
Overall height	104 mm
Temperature	- 20 / + 60 °C
Standard	EN_12528
Weight	0.143 kg
Swivel Radius	74 mm
Hardness of tread	Shore A 90
Load capacity	70 kg
Load capacity (static)	140 kg

## Structure & Mounting

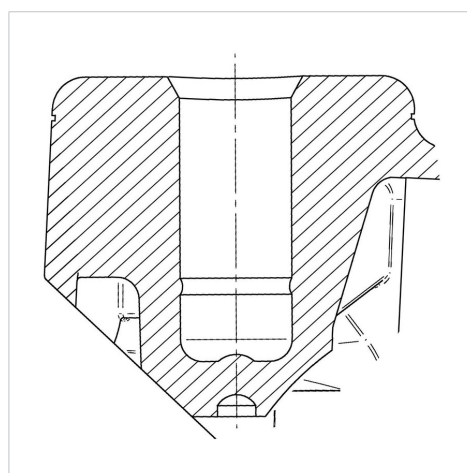

## Advantages at a glance

Roll performance	● ● ● ○ ○
Movement noise	● ● ● ○ ○
Attrition	● ● ● ○ ○
Corrosion resistance	● ● ● ○ ○