

# DURATECH

TOP085x75-Ø20 HL75

EAN 4031582331196

Wheel centre made of Polyamide, heavy duty, precision ball bearing  
Load capacities on a smooth, even surface.



BETTER MOBILITY. BETTER LIFE.



Picture may differ from original product

## Technical Data

Wheel diameter	85 mm
Wheel width	75 mm
Axle Hole-Ø	20 mm
Hub length	75 mm
Temperature	- 40 / + 80 °C
Standard	EN_12533
Weight	0.208 kg
Hardness of tread	Shore D 75
Bearing type	6204 No.
Load capacity	750 kg
Load capacity (static)	1500 kg

## Dimensions

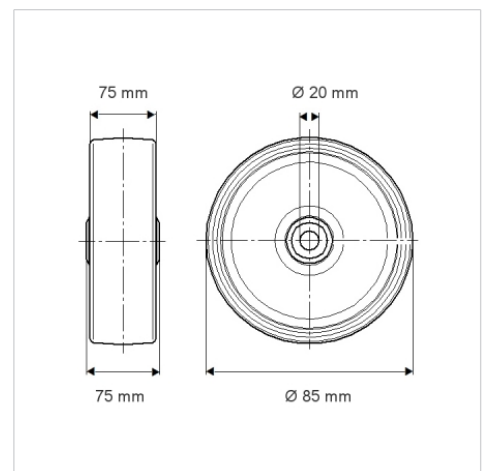

## Advantages at a glance

Roll performance	● ● ● ● ●
Movement noise	● ● ● ○ ○
Attrition	● ● ● ● ●
Corrosion resistance	● ● ● ○ ○

## Structure & Mounting

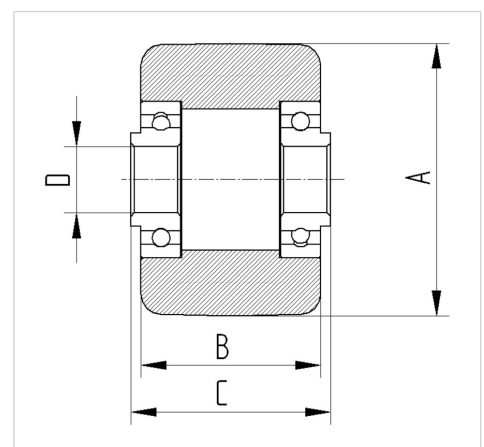

# DURATECH

TOP085x75-Ø20 HL75

EAN 4031582331196



BETTER MOBILITY. BETTER LIFE.

## Structure & Mounting

---

