

ELASTECH

IEP250x50-Ø25

EAN 4031582319767

Wheel centre made of Aluminium, Tread: black elastic-tyre, vulcanized, precision ball bearing



BETTER MOBILITY. BETTER LIFE.



Picture may differ from original product

Technical Data

Wheel diameter	250 mm
Wheel width	50 mm
Axle Hole-Ø	25 mm
Hub length	60 mm
Temperature	- 20 / + 85 °C
Standard	EN_12532
Weight	2.341 kg
Hardness of tread	Shore A 68
Load capacity	500 kg
Load capacity (static)	1000 kg

Dimensions

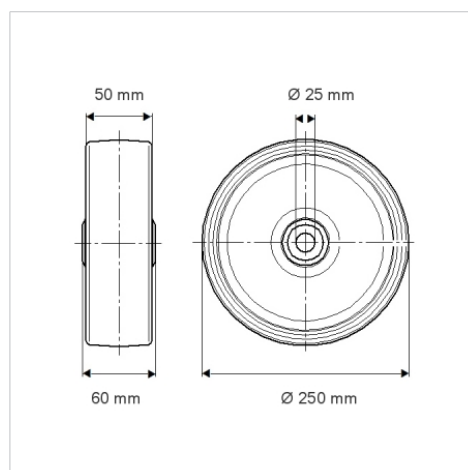

Advantages at a glance

Roll performance	● ● ● ○ ○
Movement noise	● ● ● ○ ○
Attrition	● ● ● ○ ○
Corrosion resistance	● ● ● ○ ○

Structure & Mounting

