

# ALPHA

3478POR100P62 RAL9011

EAN 4031582030402

Fixed castor, Fork made of pressed steel, bright zinc plated, blue passivated, wheel axle with nut, plate fitting.

Wheel centre made Polypropylene, roller bearing



BETTER MOBILITY. BETTER LIFE.



Picture may differ from original product

## Technical Data

Wheel diameter	100 mm
Wheel width	36 mm
Castor width	85 mm
Size of Plate	103 x 85 mm
Plate hole centres	80/77 x 60 mm
Plate hole	9 mm
Overall height	128 mm
Temperature	- 20 / + 60 °C
Standard	EN_12532
Weight	0.366 kg
Hardness of tread	Shore D 65
Load capacity	160 kg
Load capacity (static)	320 kg

## Dimensions

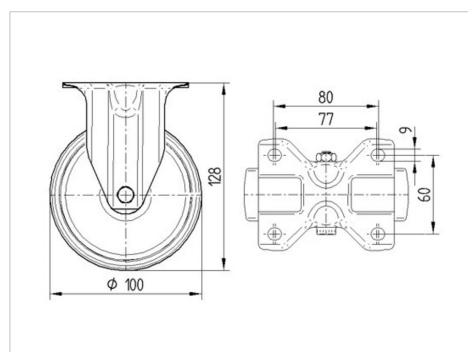

## Advantages at a glance

Roll performance	● ● ● ○ ○
Movement noise	● ● ● ○ ○
Attrition	● ● ● ● ●
Corrosion resistance	● ● ● ○ ○

# ALPHA

3478POR100P62 RAL9011

EAN 4031582030402



BETTER MOBILITY. BETTER LIFE.

## Structure & Mounting

