

COMPACTA

2198UOI025P60-40x17

EAN 4031582300284

Fixed castor, Fork made of pressed steel, bright zinc plated, blue passivated, axle riveted, plate fitting.

Wheel centre made of Polyamide, plain bearing



BETTER MOBILITY. BETTER LIFE.



Picture may differ from original product

Technical Data

Wheel diameter	25 mm
Wheel width	13 mm
Castor width	20 mm
Size of Plate	40 x 17 mm
Plate hole centres	30 mm
Plate hole	4,5 mm
Dome-Ø	20 mm
Overall height	28 mm
Temperature	- 25 / - 25 °C
Standard	EN_12530
Weight	0.018 kg
Hardness of tread	Shore D 75
Load capacity	25 kg
Load capacity (static)	50 kg

Dimensions

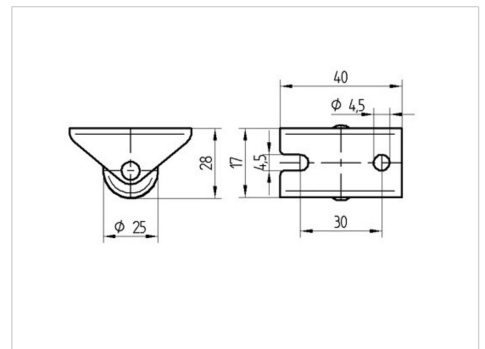

Advantages at a glance

Roll performance	● ● ● ○ ○
Movement noise	● ● ● ○ ○
Attrition	● ● ● ● ●
Corrosion resistance	● ● ● ○ ○