

NOVATECH

STP500x80-Ø50 HL90

EAN 4031582322293

Wheel centre made of pressed steel, lacquered, heavy duty, Tread: Polyurethane, casted, precision ball bearing



BETTER MOBILITY. BETTER LIFE.



Picture may differ from original product

Technical Data

Wheel diameter	500 mm
Wheel width	80 mm
Axle Hole-Ø	50 mm
Hub length	90 mm
Temperature	- 10 / + 60 °C
Standard	EN_12533
Weight	40.634 kg
Hardness of tread	Shore A 92
Load capacity	3200 kg
Load capacity (static)	6400 kg

Dimensions

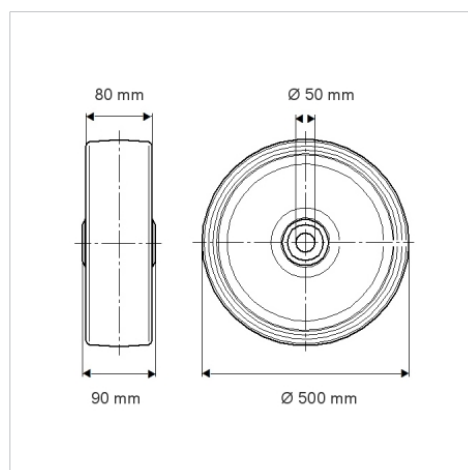

Advantages at a glance

Roll performance	● ● ● ○ ○
Movement noise	● ● ● ○ ○
Attrition	● ● ● ● ○
Corrosion resistance	● ● ● ○ ○

Structure & Mounting

