

BASETECH

POR080x34-Ø12 RAL9011

EAN 4031582320763

Wheel centre made Polypropylene, roller bearing



BETTER MOBILITY. BETTER LIFE.



Picture may differ from original product

Technical Data

Wheel diameter	80 mm
Wheel width	34 mm
Axle Hole-Ø	12 mm
Hub length	44.4 mm
Temperature	- 20 / + 60 °C
Standard	EN_12532
Weight	0.102 kg
Hardness of tread	Shore D 65
Load capacity	125 kg
Load capacity (static)	250 kg

Dimensions

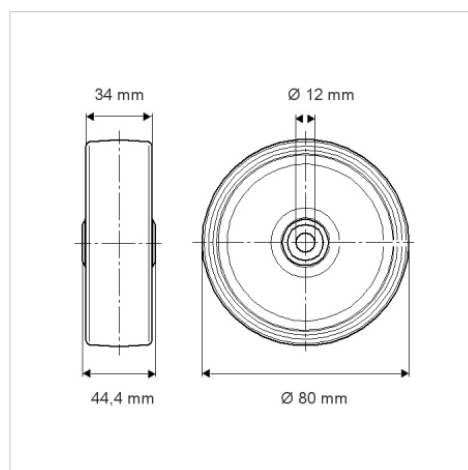

Advantages at a glance

Roll performance	● ● ● ○ ○
Movement noise	● ● ● ○ ○
Attrition	● ● ● ● ●
Corrosion resistance	● ● ● ○ ○