

PURETECH

PVO080x35-Ø12

EAN 4031582321180

Wheel centre made of Polypropylene, Tread: solid rubber, black, plain bearing



BETTER MOBILITY. BETTER LIFE.



Picture may differ from original product

Technical Data

Wheel diameter	80 mm
Wheel width	35 mm
Axle Hole-Ø	12.1 mm
Hub length	44.4 mm
Temperature	- 20 / + 60 °C
Standard	EN_12532
Weight	0.151 kg
Hardness of tread	Shore A 80
Load capacity	70 kg
Load capacity (static)	140 kg

Dimensions

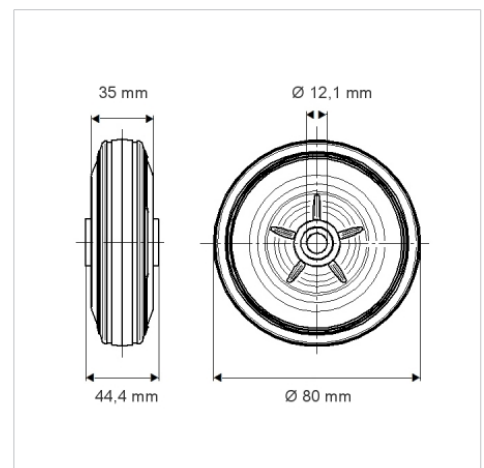

Advantages at a glance

Roll performance	● ● ○ ○ ○
Movement noise	● ● ● ○ ○
Attrition	● ● ○ ○ ○
Corrosion resistance	● ● ● ○ ○