

ZETA

4687ITP160P63 Flat

EAN 4031582050578

Swivel castor with total lock, tail end of castor, housing made of very heavy pressed steel, reinforced, bright zinc plated, blue passivated, sealed swivel double ball bearing, reinforced and heat-treated ball covers, riveted king pin, dust ring with integrated grease nipple, wheel axle with nut, plate fitting. Wheel centre made of Aluminium, Tread: Polyurethane, casted, precision ball bearing



BETTER MOBILITY. BETTER LIFE.



Picture may differ from original product

Technical Data

Wheel diameter	160 mm
Wheel width	50 mm
Castor width	96 mm
Size of Plate	137 x 105 mm
Plate hole centres	105 x 80/75 mm
Plate hole	11 mm
Dome-Ø	96 mm
Offset	55 mm
Swivel Interference	322 mm
Overall height	200 mm
Temperature	- 10 / + 60 °C
Standard	EN_12532
Weight	3.449 kg
Swivel Radius	161 mm
Hardness of tread	Shore A 92
Load capacity	800 kg
Load capacity (static)	1600 kg

Advantages at a glance

Roll performance	● ● ● ○ ○
Movement noise	● ● ● ○ ○
Attrition	● ● ● ● ○
Corrosion resistance	● ● ● ○ ○

Dimensions

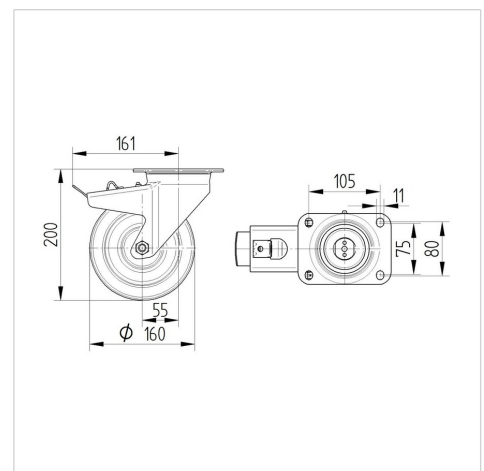

Structure & Mounting

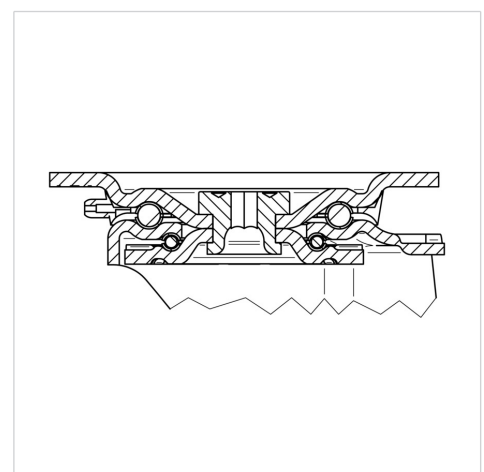

ZETA

4687ITP160P63 Flat

EAN 4031582050578



BETTER MOBILITY. BETTER LIFE.

Structure & Mounting

