

ALPHA

3478PVR100P62

EAN 4031582030655

Fixed castor, Fork made of pressed steel, bright zinc plated, blue passivated, wheel axle with nut, plate fitting.
Wheel centre made of Polypropylene, Tread: solid rubber, black, roller bearing



BETTER MOBILITY. BETTER LIFE.



Picture may differ from original product

Technical Data

Wheel diameter	100 mm
Wheel width	35 mm
Castor width	85 mm
Size of Plate	103 x 85 mm
Plate hole centres	80/77 x 60 mm
Plate hole	9 mm
Overall height	128 mm
Temperature	- 20 / + 60 °C
Standard	EN_12532
Weight	0.46 kg
Hardness of tread	Shore A 80
Load capacity	75 kg
Load capacity (static)	150 kg

Dimensions

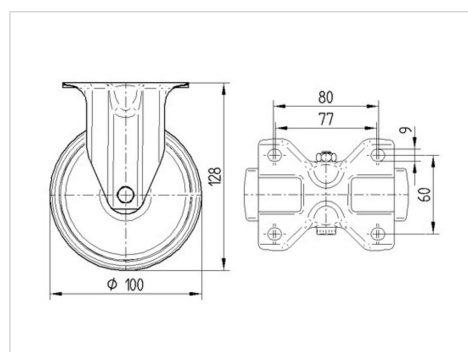

Advantages at a glance

Roll performance	● ● ● ○ ○
Movement noise	● ● ● ○ ○
Attrition	● ● ○ ○ ○
Corrosion resistance	● ● ● ○ ○

ALPHA

3478PVR100P62

EAN 4031582030655



BETTER MOBILITY. BETTER LIFE.

Structure & Mounting

