

ALPHA

3470PVR080P62

EAN 4031582010763

Swivel castor, housing made of pressed steel, bright zinc plated, blue passivated, double ball bearing swivel head, wheel axle with nut, dustguard, plate fitting. Wheel centre made of Polypropylene, Tread: solid rubber, black, roller bearing



BETTER MOBILITY. BETTER LIFE.



Picture may differ from original product

Technical Data

Wheel diameter	80 mm
Wheel width	35 mm
Castor width	75 mm
Size of Plate	105 x 80 mm
Plate hole centres	80/77 x 60 mm
Plate hole	9 mm
Dome-Ø	75 mm
Offset	40 mm
Swivel Interference	160 mm
Overall height	108 mm
Temperature	- 20 / + 60 °C
Standard	EN_12532
Weight	0.666 kg
Swivel Radius	80 mm
Hardness of tread	Shore A 80
Load capacity	70 kg
Load capacity (static)	140 kg

Dimensions

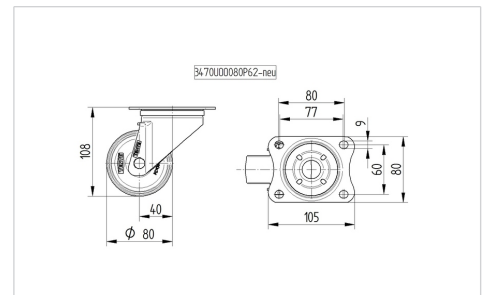

Structure & Mounting

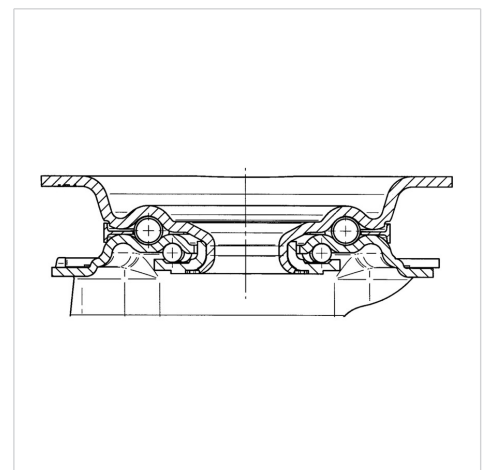

Advantages at a glance

Roll performance	● ● ● ○ ○
Movement noise	● ● ● ○ ○
Attrition	● ● ○ ○ ○
Corrosion resistance	● ● ● ○ ○

ALPHA

3470PVR080P62

EAN 4031582010763



BETTER MOBILITY. BETTER LIFE.

Structure & Mounting

