

ANIKA

5920UAI055L51-8

EAN 4031582406368

Swivel castor, housing made of Polyamide, with blind hole fitting. Wheel centre made of Polyamide, Tread: Polyurethane, plain bearing



BETTER MOBILITY. BETTER LIFE.



Picture may differ from original product

Technical Data

Wheel diameter	55 mm
Wheel width	11 mm
Castor width	37 mm
Centre hole	8 mm
Dome-Ø	18 mm
Swivel Interference	94 mm
Overall height	57 mm
Temperature	- 10 / + 40 °C
Standard	EN_12528
Weight	0.065 kg
Swivel Radius	47 mm
Hardness of tread	Shore A 92
Load capacity	40 kg
Load capacity (static)	80 kg

Advantages at a glance

Roll performance	● ● ● ○ ○
Movement noise	● ● ● ○ ○
Attrition	● ● ● ○ ○
Corrosion resistance	● ● ● ● ○

Dimensions

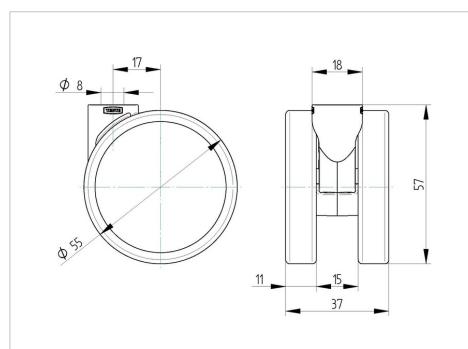

Structure & Mounting

