

MONO

A020PJH080L51-10 RAL9006

EAN 4031582317114

Swivel castor, housing made of Polypropylene, with blind hole fitting.
Wheel centre made of Polypropylene, Tread: TENTEprene (thermoplastic rubber), grey non-marking, with threadguards, plain bearing



BETTER MOBILITY. BETTER LIFE.



Picture may differ from original product

Technical Data

Wheel diameter	80 mm
Wheel width	24 mm
Centre hole	10 mm
Offset	34 mm
Swivel Interference	148 mm
Overall height	104 mm
Temperature	- 20 / + 60 °C
Standard	EN_12528
Weight	0.143 kg
Swivel Radius	74 mm
Hardness of tread	Shore A 90
Load capacity	70 kg
Load capacity (static)	140 kg

Structure & Mounting

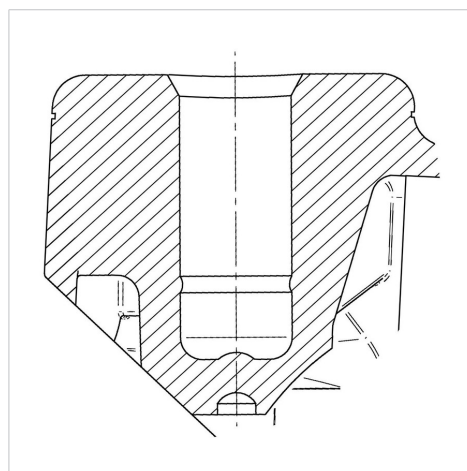

Advantages at a glance

Roll performance	● ● ● ○ ○
Movement noise	● ● ● ○ ○
Attrition	● ● ● ○ ○
Corrosion resistance	● ● ● ○ ○