

# GALEA

5071PJH100R05-22x40

EAN 4031582368437

Swivel castor with directional lock, housing made of Polyamide, double ball bearing swivel head, solid plug fitting. Wheel centre made of Polypropylene, Tread: TENTEprene (thermoplastic rubber), grey non-marking, with threadguards, plain bearing  
Hint: These castors are also with grey locking lever available.



BETTER MOBILITY. BETTER LIFE.



Picture may differ from original product

## Technical Data

Wheel diameter	100 mm
Wheel width	30 mm
Bolt-Ø	22 mm
Bolt length	40 mm
Offset	40 mm
Swivel Interference	205 mm
Overall height	139 mm
Temperature	-20 / +60 °C
Standard	EN_12530
Hardness of tread	Shore A 87
Load capacity	100 kg
Load capacity (static)	200 kg

## Advantages at a glance

Roll performance	● ● ● ○ ○
Movement noise	● ● ● ○ ○
Attrition	● ● ● ○ ○
Corrosion resistance	● ● ● ● ○

## Dimensions

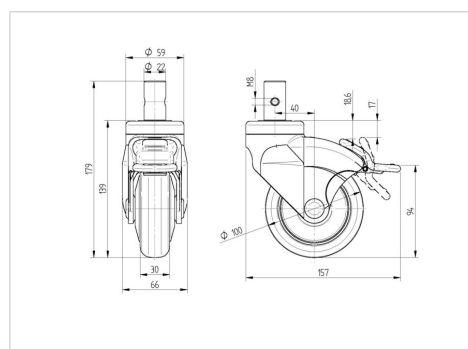

## Structure & Mounting

