

LEVINA

5377PJP125R05-22x45

EAN 4031582355239

Swivel castor with total lock, tail end of castor, housing and wheels made from high grade synthetic materials, double ball bearing swivel head, solid plug fitting. Wheel centre made of Polypropylene, Tread: TENTEprene (thermoplastic rubber), grey non-marking, precision ball bearing
Hint: These castors are also with grey locking lever available.



BETTER MOBILITY. BETTER LIFE.



Picture may differ from original product

Technical Data

Wheel diameter	125 mm
Wheel width	32 mm
Castor width	59 mm
Bolt-Ø	22 mm
Bolt length	45 mm
Dome-Ø	59 mm
Offset	38 mm
Swivel Interference	201 mm
Overall height	161 mm
Temperature	- 10 / + 40 °C
Standard	EN_12530
Weight	0.725 kg
Swivel Radius	100.5 mm
Hardness of tread	Shore A 87
Load capacity	100 kg
Load capacity (static)	200 kg

Advantages at a glance

Roll performance	● ● ● ○ ○
Movement noise	● ● ● ● ○
Attrition	● ● ● ○ ○
Corrosion resistance	● ● ● ● ○

Dimensions

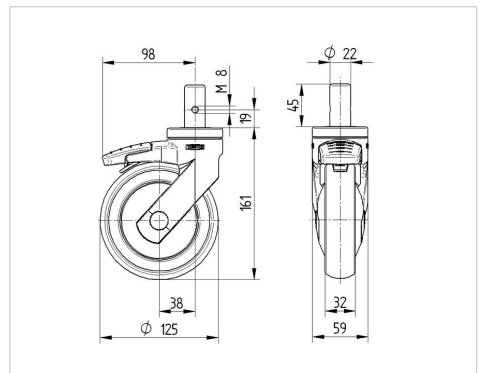

Structure & Mounting

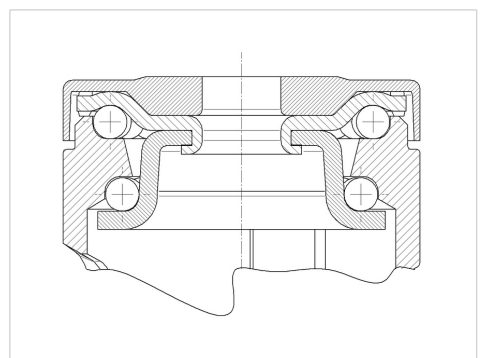

PRODUCT INFORMATION

LEVINA

5377PJP125R05-22x45

EAN 4031582355239



BETTER MOBILITY. BETTER LIFE.

Structure & Mounting

