

SUPRATECH

PJP075x25-Ø6

EAN 4031582070248

Wheel centre made of Polypropylene, Tread: TENTEprene (thermoplastic rubber), grey non-marking, precision ball bearing, with threadguards



BETTER MOBILITY. BETTER LIFE.



Picture may differ from original product

Technical Data

Wheel diameter	75 mm
Wheel width	25 mm
Axle Hole-Ø	6.3 mm
Hub length	28.2 mm
Temperature	- 20 / + 60 °C
Standard	EN_12530
Weight	0.094 kg
Hardness of tread	Shore A 87
Load capacity	75 kg
Load capacity (static)	150 kg

Dimensions

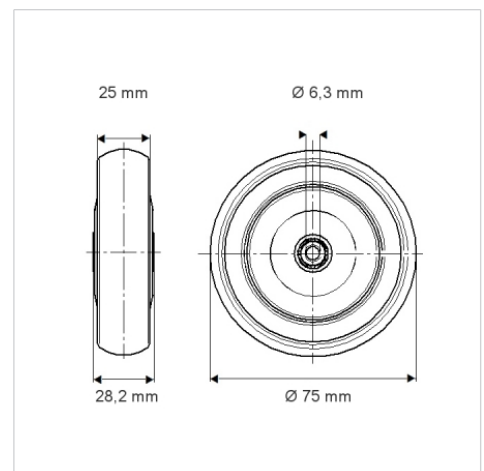

Advantages at a glance

Roll performance	● ● ● ○ ○
Movement noise	● ● ● ○ ○
Attrition	● ● ● ○ ○
Corrosion resistance	● ● ● ○ ○