

MAXTECH

UAD160x40-Ø20 HL58 red

EAN 4031582322798

Wheel centre made of Polyamide, Tread: Polyurethane, roller bearing, stainless



BETTER MOBILITY. BETTER LIFE.



Picture may differ from original product

Technical Data

Wheel diameter	160 mm
Wheel width	40 mm
Axle Hole-Ø	20 mm
Hub length	58 mm
Temperature	- 25 / + 80 °C
Standard	EN_12532
Weight	0.673 kg
Hardness of tread	Shore D 42
Load capacity	350 kg
Load capacity (static)	700 kg

Dimensions

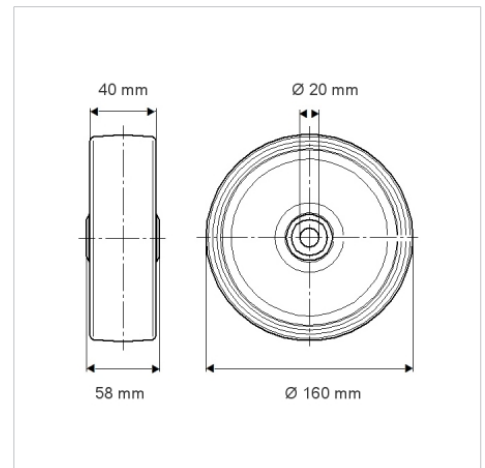

Advantages at a glance

Roll performance	● ● ● ○ ○
Movement noise	● ● ● ○ ○
Attrition	● ● ● ● ○
Corrosion resistance	● ● ● ○ ○