

# BASETECH

POO065x30-Ø12 RAL9011

EAN 4031582320718

Wheel centre made of Polypropylene, plain bearing



BETTER MOBILITY. BETTER LIFE.



Picture may differ from original product

## Technical Data

Wheel diameter	65 mm
Wheel width	30 mm
Axle Hole-Ø	12.1 mm
Hub length	34.5 mm
Temperature	- 20 / + 60 °C
Standard	EN_12532
Weight	0.047 kg
Hardness of tread	Shore D 65
Load capacity	120 kg
Load capacity (static)	240 kg

## Dimensions

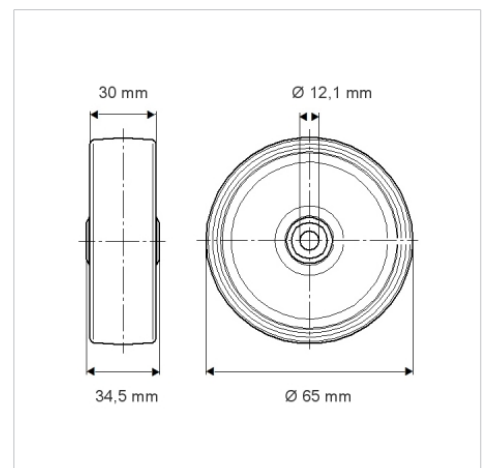

## Advantages at a glance

Roll performance	● ● ● ○ ○
Movement noise	● ● ● ○ ○
Attrition	● ● ● ● ●
Corrosion resistance	● ● ● ○ ○