

# BASETECH

POR080x34-Ø12 RAL9011

EAN 4031582320763

Wheel centre made Polypropylene, roller bearing



BETTER MOBILITY. BETTER LIFE.



Picture may differ from original product

## Technical Data

Wheel diameter	80 mm
Wheel width	34 mm
Axle Hole-Ø	12 mm
Hub length	44.4 mm
Temperature	- 20 / + 60 °C
Standard	EN_12532
Weight	0.102 kg
Hardness of tread	Shore D 65
Load capacity	125 kg
Load capacity (static)	250 kg

## Dimensions

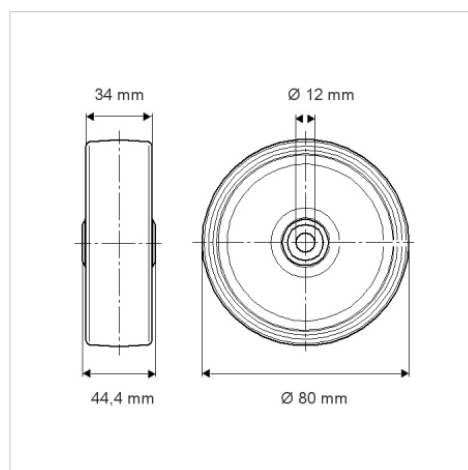

## Advantages at a glance

Roll performance	● ● ● ○ ○
Movement noise	● ● ● ○ ○
Attrition	● ● ● ● ●
Corrosion resistance	● ● ● ○ ○