

MAXTECH

XSP200x32-Ø8

EAN 4031582323689

Wheel centre made of Polyamide, electric conductive, tread made of Polyurethane, with threadguards, precision ball bearing



BETTER MOBILITY. BETTER LIFE.



Picture may differ from original product

Technical Data

Wheel diameter	200 mm
Wheel width	32 mm
Axle Hole-Ø	8.1 mm
Hub length	36.5 mm
Temperature	- 25 / + 80 °C
Standard	EN_12530
Weight	0.789 kg
Hardness of tread	Shore D 46
Load capacity	160 kg
Load capacity (static)	320 kg

Dimensions

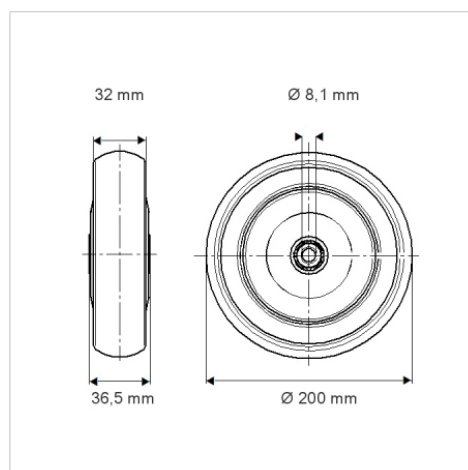

Advantages at a glance

Roll performance	● ● ● ○ ○
Movement noise	● ● ● ○ ○
Attrition	● ● ● ○ ○
Corrosion resistance	● ● ● ○ ○