

ZETA

4687ITP250P63 Flat

EAN 4031582050592

Swivel castor with total lock, tail end of castor, housing made of very heavy pressed steel, reinforced, bright zinc plated, blue passivated, sealed swivel double ball bearing, reinforced and heat-treated ball covers, riveted king pin, dust ring with integrated grease nipple, wheel axle with nut, plate fitting. Wheel centre made of Aluminium, Tread: Polyurethane, casted, precision ball bearing



BETTER MOBILITY. BETTER LIFE.



Picture may differ from original product

Technical Data

Wheel diameter	250 mm
Wheel width	55 mm
Castor width	96 mm
Size of Plate	137 x 105 mm
Plate hole centres	105 x 80/75 mm
Plate hole	11 mm
Dome-Ø	96 mm
Offset	55 mm
Swivel Interference	360 mm
Overall height	290 mm
Temperature	- 10 / + 60 °C
Standard	EN_12532
Weight	5.032 kg
Swivel Radius	180 mm
Hardness of tread	Shore A 92
Load capacity	800 kg
Load capacity (static)	1600 kg

Advantages at a glance

Roll performance	● ● ● ○ ○
Movement noise	● ● ● ○ ○
Attrition	● ● ● ● ○
Corrosion resistance	● ● ● ○ ○

Dimensions

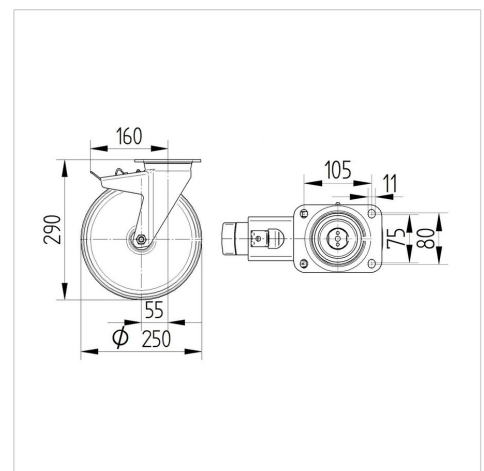

Structure & Mounting

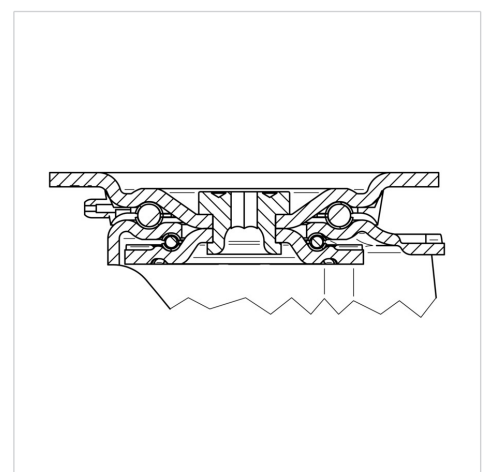

ZETA

4687ITP250P63 Flat

EAN 4031582050592



BETTER MOBILITY. BETTER LIFE.

Structure & Mounting

