

ULTRATECH

ICP200x50-Ø20

EAN 4031582445183

Wheel centre made of Aluminium, Tread: Polyurethane, casted, Ultratech, suitable especially for higher speeds of up to 16 km/h, precision ball bearing



BETTER MOBILITY. BETTER LIFE.



Picture may differ from original product

Technical Data

Wheel diameter	200 mm
Wheel width	50 mm
Axle Hole-Ø	20 mm
Hub length	60 mm
Temperature	- 20 / + 60 °C
Standard	EN_12532
Weight	1.3 kg
Hardness of tread	Shore A 92
Load capacity	800 kg
Load capacity (static)	1600 kg

Dimensions

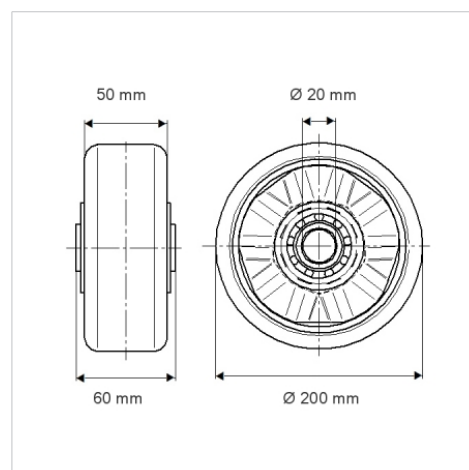

Advantages at a glance

Roll performance	● ● ● ○ ○
Movement noise	● ● ● ○ ○
Attrition	● ● ● ● ○
Corrosion resistance	● ● ● ○ ○

Structure & Mounting

