

BASETECH

PQR260x85-Ø25 HL74 2PR

EAN 4031582321081

Wheel centre made of Polypropylene, Tread: pneumatic tyre, roller bearing, block profile



BETTER MOBILITY. BETTER LIFE.



Picture may differ from original product

Technical Data

Wheel diameter	260 mm
Wheel width	85 mm
Axle Hole-Ø	25 mm
Hub length	74 mm
Weight	1.04 kg
Hardness of tread	Shore A 55
Load capacity	150 kg
Load capacity (static)	150 kg

Dimensions

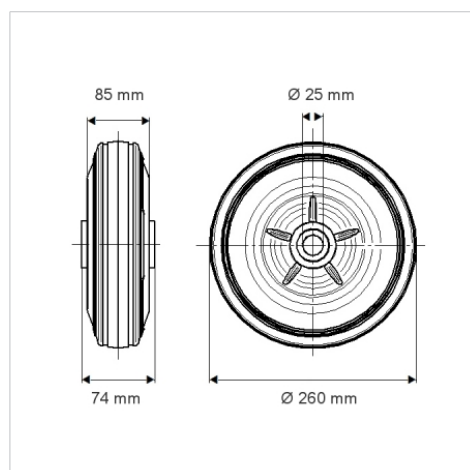

Advantages at a glance

Roll performance	● ● ● ○ ○
Movement noise	● ● ● ○ ○
Attrition	● ● ● ○ ○
Corrosion resistance	● ● ● ○ ○