

DELTA

3648ITP160P63 Flat

EAN 4031582337396

Fixed castor, Fork made of heavy pressed steel, bright zinc plated, blue passivated, wheel axle with nut, plate fitting.
Wheel centre made of Aluminium, Tread: Polyurethane, casted, precision ball bearing



BETTER MOBILITY. BETTER LIFE.



Picture may differ from original product

Technical Data

Wheel diameter	160 mm
Wheel width	50 mm
Castor width	115 mm
Size of Plate	137 x 115,0 mm
Plate hole centres	105 x 80/75 mm
Plate hole	11 mm
Dome-Ø	115 mm
Overall height	210 mm
Temperature	- 10 / + 60 °C
Standard	EN_12532
Weight	2.081 kg
Hardness of tread	Shore A 92
Load capacity	600 kg
Load capacity (static)	1200 kg

Dimensions

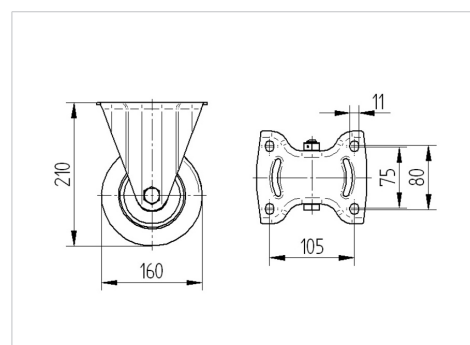

Advantages at a glance

Roll performance	● ● ● ○ ○
Movement noise	● ● ● ○ ○
Attrition	● ● ● ● ○
Corrosion resistance	● ● ● ○ ○

DELTA

3648ITP160P63 Flat

EAN 4031582337396



BETTER MOBILITY. BETTER LIFE.

Structure & Mounting

