

DELTA

3641ITP160P63 Flat

EAN 4031582337457

Swivel castor with directional lock, housing made of heavy pressed steel, bright zinc plated, blue passivated, precision ball bearing swivel head, sealed, wheel axle with nut, plate fitting. Wheel centre made of Aluminium, Tread: Polyurethane, casted, precision ball bearing



BETTER MOBILITY. BETTER LIFE.



Picture may differ from original product

Technical Data

Wheel diameter	160 mm
Wheel width	50 mm
Castor width	94 mm
Size of Plate	137 x 105 mm
Plate hole centres	105 x 80/75 mm
Plate hole	11 mm
Dome-Ø	94 mm
Offset	55 mm
Swivel Interference	270 mm
Overall height	210 mm
Temperature	- 10 / + 60 °C
Standard	EN_12532
Weight	3.318 kg
Swivel Radius	135 mm
Hardness of tread	Shore A 92
Load capacity	600 kg
Load capacity (static)	1200 kg

Dimensions

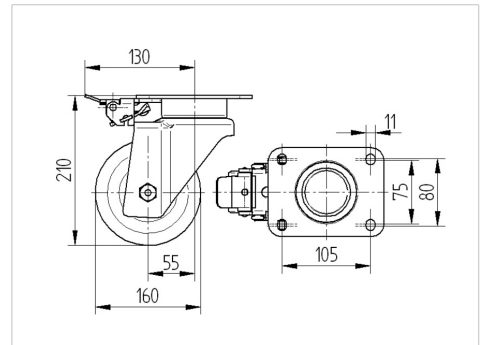

Structure & Mounting

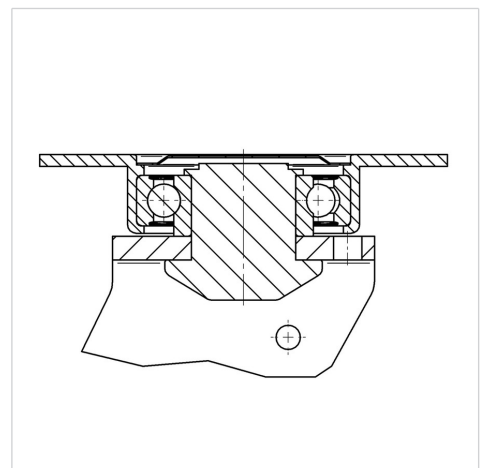

Advantages at a glance

Roll performance	● ● ● ○ ○
Movement noise	● ● ● ○ ○
Attrition	● ● ● ● ○
Corrosion resistance	● ● ● ○ ○

DELTA

3641ITP160P63 Flat

EAN 4031582337457



BETTER MOBILITY. BETTER LIFE.

Structure & Mounting

