

PURETECH

PVR100x35-Ø12

EAN 4031582321258

Wheel center made of Polypropylene, Tread: solid rubber, black, roller bearing



BETTER MOBILITY. BETTER LIFE.



Picture may differ from original product

Technical Data

Wheel diameter	3.94 in
Wheel width	1.38 in
Axle Hole-Ø	0.47 in
Hub length	1.75 in
Temperature	- 4 / + 140 °F
Standard	EN 12532
Weight	0.644 lbs
Hardness of tread	Shore A 80
Load capacity (dynamic)	165 lbs
Load capacity (static)	330 lbs

Dimensions

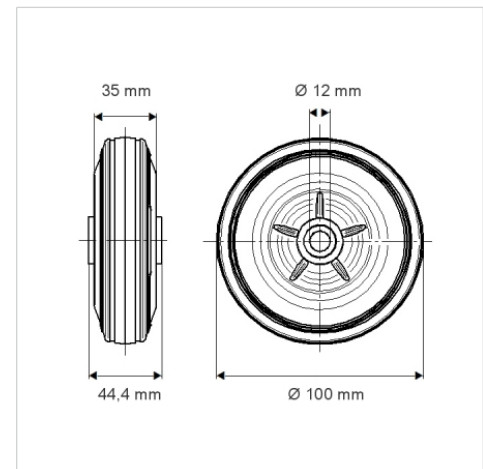

Advantages at a glance

Roll performance	● ● ● ○ ○
Movement noise	● ● ● ○ ○
Attrition	● ● ○ ○ ○
Corrosion resistance	● ● ● ○ ○