

# MAXTECH

XSP200x32-Ø8

EAN 4031582323689

Wheel centre made of Polyamide, electric conductive, tread made of Polyurethane, with threadguards, precision ball bearing



BETTER MOBILITY. BETTER LIFE.



Picture may differ from original product

## Technical Data

Wheel diameter	200 mm
Wheel width	32 mm
Axle Hole-Ø	8.1 mm
Hub length	36.5 mm
Temperature	- 25 / + 80 °C
Standard	EN_12530
Weight	0.789 kg
Hardness of tread	Shore D 46
Load capacity	160 kg
Load capacity (static)	320 kg

## Dimensions

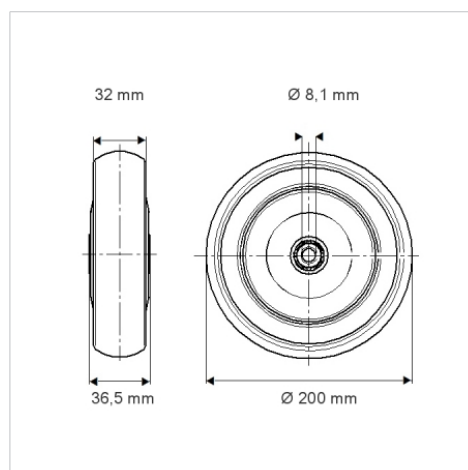

## Advantages at a glance

Roll performance	● ● ● ○ ○
Movement noise	● ● ● ○ ○
Attrition	● ● ● ○ ○
Corrosion resistance	● ● ● ○ ○