

SUPRATECH

PJP200x32-Ø8

EAN 4031582070286

Wheel centre made of Polypropylene, Tread: TENTEprene (thermoplastic rubber), grey non-marking, precision ball bearing, with threadguards



BETTER MOBILITY. BETTER LIFE.



Picture may differ from original product

Technical Data

Wheel diameter	200 mm
Wheel width	32 mm
Axle Hole-Ø	8.1 mm
Hub length	36.5 mm
Temperature	- 20 / + 60 °C
Standard	EN_12530
Weight	0.67 kg
Hardness of tread	Shore A 80
Load capacity	100 kg
Load capacity (static)	200 kg

Dimensions

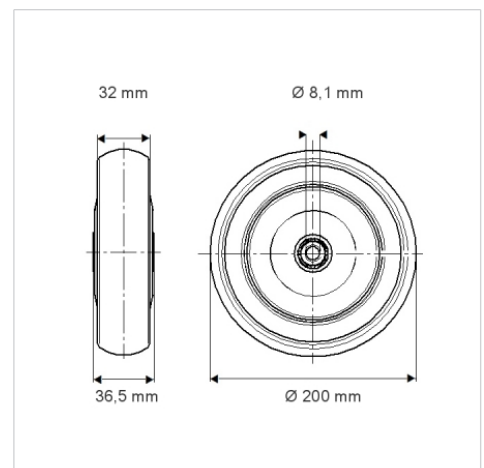

Advantages at a glance

Roll performance	● ● ● ○ ○
Movement noise	● ● ● ○ ○
Attrition	● ● ● ○ ○
Corrosion resistance	● ● ● ○ ○