

OMIKRON

9258FTP250P65

EAN 4031582314076

Fixed castor, Fork and plate steel welded, zinc plated, blue passivated, wheel axle with nut, plate fitting.

Wheel centre made of cast iron, Tread: Polyurethane, casted, precision ball bearing



BETTER MOBILITY. BETTER LIFE.



Picture may differ from original product

Technical Data

Wheel diameter	250 mm
Wheel width	100 mm
Castor width	182 mm
Size of Plate	200 x 160 mm
Plate hole centres	160 x 120 mm
Plate hole	15 mm
Dome-Ø	160 mm
Overall height	325 mm
Temperature	- 10 / + 60 °C
Standard	EN_12533
Weight	23.128 kg
Hardness of tread	Shore A 92
Load capacity	2640 kg
Load capacity (static)	5280 kg

Dimensions

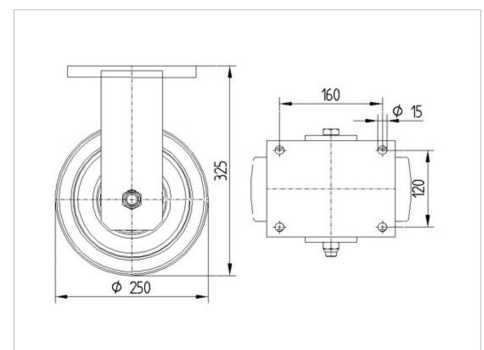

Advantages at a glance

Roll performance	● ● ● ● ○
Movement noise	● ● ● ○ ○
Attrition	● ● ● ● ○
Corrosion resistance	● ● ● ○ ○

OMIKRON

9258FTP250P65

EAN 4031582314076



BETTER MOBILITY. BETTER LIFE.

Structure & Mounting

